



## Working Paper No. 980

---

### **Balance Sheet Effects of a Currency Devaluation: A Stock-Flow Consistent Framework for Mexico**

by

**Lorenzo Nalin**

National Autonomous University of Mexico (UNAM)

and

**Giuliano Toshio Yajima**

Sapienza University of Rome

December 2020

---

\*We are grateful to Juan Carlos Moreno Brid, Esteban Perez Caldentey, and Michalis Nikiforos for their useful comments to a first draft of this paper. Of course, any remaining error should be attributed to ourselves.

The Levy Economics Institute Working Paper Collection presents research in progress by Levy Institute scholars and conference participants. The purpose of the series is to disseminate ideas to and elicit comments from academics and professionals.

Levy Economics Institute of Bard College, founded in 1986, is a nonprofit, nonpartisan, independently funded research organization devoted to public service. Through scholarship and economic research it generates viable, effective public policy responses to important economic problems that profoundly affect the quality of life in the United States and abroad.

Levy Economics Institute  
P.O. Box 5000  
Annandale-on-Hudson, NY 12504-5000  
<http://www.levyinstitute.org>

Copyright © Levy Economics Institute 2020 All rights reserved

ISSN 1547-366X

## **ABSTRACT**

This working paper empirically and theoretically analyzes the exchange rate's role in Mexico's development for the period 2004–19. We test the hypothesis of the re(emergence) of the balance sheet effect due to an increase in external debt in the nonfinancial corporate sector; higher foreign debt would affect private investment after episodes of real currency depreciation, in the spirit of the literature put forward by Gertler, Gilchrist, and Natalucci (2007) and Céspedes, Chang, and Velasco (2004). We build a stock-flow consistent (SFC) model, following the OPENFLEX model proposed in Godley and Lavoie (2006), to explore the balance sheet implications from a theoretical perspective. We simulate the 2014 fall in the Mexican peso generated by the drop in oil prices to replicate stylized facts for Mexico for the period under investigation. The scenario analysis points to a hysteresis effect of the real exchange rate (RER) depreciation on investment flows. That is, firms' investment ratio does not completely recover from negative shocks in the currency.

**KEYWORDS:** International Finance Forecasting and Simulation; Models; Applications; Foreign Exchange; Macro-Based Behavioral Economics

**JEL CLASSIFICATIONS:** F37; F31; E7

## 1 INTRODUCTION

From 2004 to 2014, global prices for raw materials soared and oil's price increased from \$35 per barrel to \$110. During that time, the Mexican economy experienced an increase in financial inflows, especially government fixed income securities (Bastourre and Zeolla 2017). The low interest environment occurred in concomitance with the commodity prices boom period that the Latin American region was experiencing, a factor that helped to attract financial capital to Latin American countries, including Mexico (Gruss 2014). However, since the fall in oil prices in September 2014—an event that marked the end of the global commodity price boom—the Mexican economy has suffered from flow reversal in fixed income and derivative markets; as a result, the currency depreciated roughly 35 percent in real terms and the currency has remained on average 15 percent more depreciated than before the shock (2004–14). From 2015 to 2019, exports were the only GDP component that benefitted from international price competitiveness, growing from 26 percent to 35 percent of total GDP. While exports grew throughout the period, private investment decelerated and, from mid-2015, declined. Gross fixed capital formation as a share of GDP decreased 2.2 percentage points from 2015 to 2019, private capital formation declined 0.68 percent, and public capital formation declined 1.2 percent. Among the most affected investment components, nonresidential investment felt 4.27 percent per year on average, followed by investment in domestic equipment and machinery with a decrease of an average of 0.43 percent per year. Also, the public sector and households appear to have performed poorly after the 2014 depreciation. The debt-to-GDP ratio increased from 49 percent to 53.5 percent, government-spending-to-GDP decreased from 19 percent to 17 percent, and household consumption as a share of GDP fell from approximately 69 percent to around 66.5 percent. As a result, per capita GDP growth during the period was steady, at around 1.4 percent (versus the previous 2 percent in 2010–14).<sup>1</sup>

Based on the limited evidence of a positive association between currency depreciation and expansionary macroeconomic performance, we advance the hypothesis that for Mexico during the period 2004–19, real depreciation was not favorable for capital accumulation in the private sector due to the (re)emergence of the balance sheet effect for nonfinancial firms. Indeed, the nonfinancial

---

<sup>1</sup> Data presented are based on the authors' calculations with data from the Bank for International Settlements (BIS), Bloomberg, and Mexico's national statistical agency, the Instituto Nacional de Estadística y Geografía (INEGI).

sector increased financing its activities through international savings, expanding their balance sheet's exposure to foreign liability revaluations (Chui, Kuruc, and Turner 2016).

To explore the theoretical implications of the balance sheet effect, we develop a stock-flow consistent model (SFC) in the tradition of the OPENFLEX model presented in Godley and Lavoie (2006). SFC models are *demand-side* models, based on the tradition of Tobin (1969, 1982) and Brainard and Tobin (1968), expanded by the Cambridge Group during the 1980s by Cripps and Godley (1976), and finally reconciled in Godley and Lavoie's (2006) book, *Monetary Economics*. The SFC methodology is based on macroeconomic accounting, aimed at tracking transactions between sectors, assets, and countries. Those relationships are modeled by looking at the national accounts system. There are three reasons why we opted for this methodology. First, it provides an alternative framework for the interaction between the financial and real sectors in an open economy (Godley and Lavoie 2006). Additionally, it encompasses a portfolio approach—based on the seminal work of Brainard and Tobin (1968), Tobin (1969; 1982), Tobin and Macedo (1980), and Backus et al. (1980)—to assess the impact of financial flows on the real exchange rate (RER), and their consequences on macroeconomic variables. Finally, it properly addresses center-periphery asymmetries existing between developed and developing economies.

Results from simulations emphasize how debt revaluation affects balance sheets, discouraging private, nonfinancial investment. The model shows that during economic expansionary phases, nonfinancial firms issue external debt to finance investment and face growing demand. However, as soon as depreciation materializes, firms find themselves with a higher stock of debt and a devaluated domestic currency. The final effect is the revaluation of debt that might lead to a lower level of investment flows, especially for those firms that already suffer currency mismatches (Chui, Kuruc, and Turner 2016). Simulations also show that after depreciation, the system finds a new equilibrium, but with a higher stock of debt and lower investment flow. This would explain, in our view, why in its recent history Mexico experienced a constant increase in external debt in the private sector as well as a lower investment ratio.

## 2 LITERATURE REVIEW

The literature on the exchange rate has identified several channels through which this variable can impact income and income growth in a small, open economy. Transmission mechanisms can be summarized into four groups, the first two of them pointing toward a positive causation while the others argue the opposite: i) the trade channel; ii) the investment channel; iii) the redistribution channel; and iv) the financial/balance sheet channel.

- i) The *trade channel* relates to the price effect, that is, the competitiveness of domestic tradable goods with respect to foreign peers, which ultimately might lead to the increase in the demand for exports. This channel finds its origin in the Mundell-Fleming model and balance-of-payment restrictions. That is, under certain specific conditions—such as increasing global demand and a limited propensity to import—the undervalued currency can promote medium-run growth in the external sector and, consequently, sustainable economic growth (Thirlwall 1979; Thirlwall and Hussain 1982; Moreno-Brid 1999; Pérez Caldentey and Moreno-Brid 2019).
- ii) The *investment channel* concerns the effect of currency devaluation on the profit rate, in accordance with Frenkel and Ros (2006), Rodrik (2008), Bresser-Pereira (2008), Rapetti (2013), and Ros (2015). As real wages decrease, the profit rate grows, stimulating capital accumulation. Ultimately, this channel also needs to account for firms' productive structure and the technology domestically available for different sectors of the economy, as mentioned by Aghion, Bacchetta, and Banerjee (2001) and Agénor and Montiel (1999). Not all sectors can rely on domestic supply of those capital goods needed in their production lines. Thus, some manufacturers depend on imported inputs, a factor that might outweigh the benefit of lower real wages in case of currency depreciation, reducing the profit margin rate.
- iii) The *redistribution channel* refers to the effect of a currency depreciation on wages. Probably the most influential work on it is the Díaz-Alejandro effect (1963)—initially addressed in Alexander (1952) and successively by Krugman and Taylor (1978).<sup>2</sup> It argues that real

---

<sup>2</sup> Krugman and Taylor (1978) also add that devaluation has a negative effect on growth due two important factors: first, in the case that imports initially exceed exports; second, if the government revenues are increased by devaluation.

depreciation leads to inflationary pressure, which implies a reduction in real wages.

Thereby, it affects private consumption, producing a redistribution of income from workers in favor of entrepreneurs. Provided that workers have a higher propensity to consume than entrepreneurs, redistribution increases the rate of savings at the expense of consumption. Recently, Ribeiro, McCombie, and Lima (2019) have shown that when the labor income share is taken as an additional control in measuring the direct impact of exchange rate misalignment on growth, this ceases to be statistically significant.

- iv) Finally, there is a financial side of the currency devaluation, which is composed of the loss in firms' net worth—the so-called *balance sheet effect*—generated by the revaluation of foreign liabilities and the consequent increase in the risk premium (Bernanke and Gertler 1989; Gertler, Gilchrist, and Natalucci 2007; Céspedes, Chang, and Velasco 2004; Bernanke, Gertler, and Gilchrist 1994). According to these works, it is necessary to evaluate the effect of an exchange rate depreciation on a firm's balance sheet, since this balance sheet effect could negatively impact private investment.

The financial impact of a RER depreciation has received relatively less attention in recent years. Major contributions on balance sheet channel are found in the works of Bernanke and Gertler (1989), Greenwald and Stiglitz (1993), Sachs, Tornell, and Velasco (1996), Kiyotaki and Moore (1997), Furman et al. (1998), Radelet and Sachs (1998) Krugman (1999), Chang and Velasco (1999), Gertler, Gilchrist, and Natalucci (2007), and Céspedes, Chang, and Velasco (2004), and is related to Bernanke, Gertler, and Gilchrist's (1994) financial accelerator theory. This family of models is also defined as open economy financial accelerator models and was born during the 1990s to study currency crises experienced in emerging countries at the time (Delli Gatti et al. 2007). They explicitly take into account the problems posed by foreign currency debt (Krugman 1999).

According to the aforementioned authors, it is necessary to evaluate the effect of exchange rate depreciation on firm's balance sheet, since this could negatively impact private investment through a decrease in the net wealth effect and higher risk premiums that firms experience when facing currency depreciation. On the one hand, authors recognize the positive effect of a RER depreciation on trade in the external sector, in line with the tradition of the Mundell-Fleming model. On the other hand, they consider the effect on firms with foreign exchange-denominated liabilities. For these companies, exchange rate depreciation would lead to a negative wealth effect. The result is an

increase in the risk premium and a decrease in access to credit, with a consequent decrease in private investment.

Bernanke and Gertler (1989) developed a business cycle model that includes a financial system, following Diamond (1965), to study periods of financial distress, followed by depreciation and reduction of net wealth. They show that with the presence of financial turmoil, agency costs are higher and, ultimately, they lead to a decrease in physical investment (Bernanke and Gertler 1995). Sachs (1989) argues a country suffers from the *debt overhang* problem when it accumulates a high stock of external debt, creating in potential investors the fear of future taxes on their returns (implicit or explicit), what Deshpande (1997) defines as the *debt overhang and the disincentive to invest*. Bernanke and Gertler (2000) argue that the magnitude of asset price fluctuations generated by currency devaluations do not always create the credit-market frictions mentioned in Bernanke and Gertler (1989). The initial state of households', firms', and intermediaries' balances sheets might lead to different outcomes. In this sense, Kiyotaki and Moore (1997) stress the role of asset prices and collateralizable net worth after a currency devaluation.

Aghion, Bacchetta, and Banerjee (2001), studying the Asian financial crisis, develop a model where a small, emerging, financially liberalized economy can suffer destabilizing effects in the face of monetary shocks. They argue that output volatility could be avoided if the economy opens to foreign direct investment only. Krugman (1999) develops a theoretical model to replicate stylized facts for the Asian crisis in 1997, which later will be defined by the literature as the “third generation” crisis models. He shows the dilemma around stabilizing RER depreciation when the economy is facing a shock. On the one hand, interest rates might rise to stabilize the currency, which could reduce investment. On the other hand, the interest rate hike could be avoided and the currency not stabilized, but in this case the impact of depreciation could be even worse, as its effects would be self-reinforcing through the decline in output and investment. Céspedes, Chang, and Velasco (2004) simulate two different models, one in which the economy is characterized by financial fragility—expressed by a high level of corporate indebtedness—and another is an economy with robust finances. The authors show analytically that the financial condition of the corporate sector—fragility or resilience—affects the depreciation's outcome. There will be an expansionary effect via trade in the case of robust finance, while the balance sheet effect will predominate in the case of excessive indebtedness before the depreciation. Cavallo et al. (2005)

provide a further explanation of the currency depreciation's financial effect. They study, theoretically and empirically, the consequences of RER depreciation on the value of assets and liabilities on the balance sheets of companies in emerging countries. They focus on the implications for growth and investment in the presence of a financial crisis. The authors claim that during episodes of financial crisis, a financial constraint exists—a level of depreciation above which investors engage in a domestic asset selloff—that generates further exchange rate depreciation, an effect that authors define as *overshooting*. Exchange rate depreciation due to overshooting causes a negative wealth effect that aggravates the fall in output and private investment generated by the crisis, especially in the case of firms with high foreign debt ratios. Delli Gatti et al. (2007) build a model based on Greenwald and Stiglitz (1993) and Greenwald (1998). They argue that depreciation effects materialize in two different moments. The first round (direct) effect and second round (indirect) effect. The former consists of a positive effect on exports and negative effect on net worth due to higher input costs for firms. The latter is the upward adjustment in interest rates due to the increased risk premium after depreciation. The vision of their balance sheet is additionally oriented toward the effect on firms' creditworthiness; that is, depreciation reduces the wealth of the company and increases the risk premium, which makes access to external financing for new projects difficult.

Empirically, econometric studies confirm that devaluations are more likely to have a negative effect on output and growth in countries with high external debt burdens (Forbes 2002; Galindo, Panizza, and Schiantarelli 2003; Blecker and Razmi 2008; Kearns and Patel 2016). The effect has been largely validated for emerging markets, including the Latin American region, using data that generally cover the end of the 1990s and beginning of the 2000s.

Forbes (2002) uses a sample of 13,500 firms from 42 countries to examine the impact of 12 major depreciations on firms' performance between 1997 and 2000. He finds empirical evidence of depreciation's negative effect on net income, but a positive relationship with market capitalization. The latter might suggest, according to the author, that depreciations increase the present value of firms' expected future profits (through higher exports). He also suggests that the final effect of depreciation on investment depends on output type, foreign sales exposure, production structure, debt outstanding, size, and profitability. Galindo, Panizza, and Schiantarelli (2003) found that firms in Latin American might possibly reverse the benefits of expansionary devaluation in the Mundell-Fleming tradition due to excess dollarization of debt. They qualitatively study the evolution of the



currency composition of firms' liabilities in six large Latin American economies (Argentina, Brazil, Chile, Colombia, Mexico, and Peru). They calculate the share of foreign currency debt in total debt for the year 2000 showing that all six countries experienced increased penetration of foreign debt and warn about the balance sheet effect on depreciation given high stocks of debt.

Benavente, Johnson, and Morande (2003) study the dichotomy between boosts in export revenues and financial net worth on Chilean listed companies for the period 1994–2001. They evaluated the impact of the Asian financial crisis (1997–99) on firms with dollar debt elements on their balance sheets. Using panel data and generalized methods of moments (GMM) methodology, they did not find statistical evidence of the balance sheet effect. They argue that those results are influenced by the fact most of the firms in their sample are exporters, which implies that they have a natural hedge over currency fluctuation derived from nature of their sales in foreign currency. They also did not find evidence of a positive effect of depreciation on investment, as the international environment was lacking a strong recovery in global demand.

Janot, Garcia, and Novaes (2008) study the balance sheet effect of the 2001 financial crisis. They use a logit analysis of a sample of 190 companies in Brazil. They split the sample between hedged firms (as a control group) and firms with external currency positions (not hedged). They found that firms with currency mismatches reduced investment by 8.1 percent compared to the control group. They also look specifically at exporters. They find that among exporting firms, those with currency mismatches had 12.4 percent lower investment than those with hedged positions.

Blecker and Razmi (2008) study a sample of 17 developing countries for the period 1983–2004 using annual data to study the expansionary hypothesis for the RER. They test the “contractionary devaluation” hypothesis: that a lower relative price of exports (real depreciation) from a developing country with respect to industrialized countries has a negative effect on the depreciating country's own short-run growth rate, in spite of any possible stimulus to exports. This is because industrialized countries are providers of credit and capital goods to developing countries.

However, researchers do not always find evidence of the balance sheet effect at work. For instance, Bleakley and Cowan (2010) studied 3,000 publicly listed firms from 15 emerging markets to see how investment reacts to capital flight when firms have maturity mismatches by estimating the

effect on investment of the interaction of short-term exposure and aggregate capital flight at the firm level from 1991 to 2002. They did not find statistical evidence. Bonomo, Martins, and Pinto (2003), using a sample of 163 firms, did not find statistical evidence of balance sheet effects for Brazil for the period 1990–2002. Echeverry et al. (2003) study the case of Colombia for the period 1995–2001 using 3,500 firms and they find little statistical evidence of the balance sheet effect, as the coefficient for the interaction between debt and the exchange rate was negatively signed, but statistically insignificant.

In recent times (since the global financial crisis of 2008), the share of foreign-currency denominated liabilities on the balance sheets of nonfinancial corporations has increased sharply in many middle-income countries (Chui, Kuruc, and Turner 2016), suggesting balance sheet effects will remain an important feature in emerging countries. Chui, Kuruc, and Turner (2016) construct different currency mismatch measures to highlight how the foreign currency position of nonfinancial companies in emerging countries has worsened since 2010 as a result of the massive issuance of dollarized debt generated by low international interest rates. The result is a fragile balance sheet in the 280 companies analyzed since the increase in dollar debt has not been accompanied by an increase in income from exports. The result is therefore an increase in the risk premium and a decrease in profitability of the companies analyzed. Both elements negatively influence access to credit and, therefore, private investment.

Using a sample of 1,000 companies, Serena and Sousa (2017) empirically study the effect of a real depreciation on the investment of companies in 36 countries. The authors find that the level of dollarized debt is a crucial element in detecting the investment behavior of private companies. Moreover, the bond market and the maturity of the debt also influence the final decision on the level of corporate investment. Authors conclude that the effect of a depreciation will be a contraction in investment if the debt is issued in dollars, while it will be an expansion if the debt is denominated in local currency. In the first case the depreciation decreases the debt stock in nominal terms; in the second case it increases it. Moreover, the negative effect on the balance sheet will have a greater magnitude according to the duration of the bonds, since companies that issue long-term bonds in dollars will have a more adverse effect when the currency depreciates in real terms, as they must pay more service on the debt in dollars for an extended period of time.

Hofmann, Shim, and Shin (2016) study the financial risk of exchange rate volatility from the point of view of an exchange rate appreciation. The authors empirically study the connection between the exchange rate and the sovereign yield differential between emerging and developing countries. They find that appreciations in the nominal exchange rate have the effect of lowering emerging countries' risk premium and attracting capital. However, when the multilateral RER also appreciates, there is an increase in the risk premium of the emerging countries, since financial agents discount a contraction in exports and imbalances in the balance of payments caused by currency appreciation in advance.

### **3 MODEL DESCRIPTION**

Following Tobin and Macedo (1980), Backus et al. (1980), Godley (1996, 1999), Godley and Lavoie (2006), and Izurieta (2003), we describe two simple economies: Mexico (MX) and the United States (US). Table 1 reports the flow diagram of our model, while table 2 and table 3 show the balance sheet and transaction flow matrix, respectively. Both economies are composed of five sectors (government, central banks, firms, financial intermediaries, and households) and six financial assets, namely money (HPM), deposits, foreign and domestic bills, and two securities called “commodity based asset” (CBA) and “derivative” (DER).

Structured notes as well as the financial intermediaries both represent a modification of the canonical OPENFLEX model, and they have been proposed in Nalin and Yajima (2019). Financial intermediaries offer financial products to the public and to do so, they are able to securitize assets, i.e., they can pool assets to create new financial securities and sell them to investors (Henderson, Pearson, and Wang 2015). Financial products are distributed to the domestic household sector, which accounts for them as an asset. The financial sector does not expressly consider commercial banks, as their role in distributing financial instruments to households would be marginal.

We assume that the US financial sector has the ability to create ad hoc financial products. The process of securitization follows the logic that US financial intermediaries buy MX bills and

securitize them in a new product, whose price not only depends on the MX bills' yield, but also follows the dynamics of commodity markets. Ultimately, they sell this product to US domestic households in the form of CBAs.

US financial intermediaries do perform another function, namely, the provision of liquidity to domestic Mexican firms. This represents a step toward a more realistic depiction of deeply integrated financial markets with respect to Nalin and Yajima (2019); as a result, the present extension incorporates the issuance of corporate securities in foreign bond markets.

**Table 1. Balance Sheet Matrix**

	US					\$	#					$\Sigma$
	Households	Production	Financial sector	Government	Central bank		Households	Production	Financial sector	Government	Central bank	
Deposits	+Dh		-D			xr\$	+Dh		-D			0
Corporate Bills\$		-Bc#\$				xr\$			+Bc#\$			0
Corporate Bills#			+Bc\$#			xr\$		-Bc#\$				0
Treasury bills#			+Bb\$#			xr\$	+Bh#		+Bb#	-B#	+Bcb#	0
Treasury bills\$	+Bh\$		+Bb\$	-B\$	+Bcb\$	xr\$			+Bb#\$		+Bcb#\$	0
CBA\$	+pCBAh		-pCBAh			xr\$						0
Derivatives						xr\$	+pDERh		-pDERh			0
Capital Stock		+K				xr\$		+K				K
High-powered money	+Hh		+Hb		-H	xr\$	+Hh		+Hb		-H	0
Balance	- V	0	0	- NW <sub>g</sub>	- NW <sub>cb</sub>		- V	0	0	- NW <sub>g</sub>	- NW <sub>cb</sub>	0
$\Sigma$	0		0	0	0		0		0	0	0	0

Central banks are in charge of the supply of money ( $H$ ); the stock of money that households own ( $+H$ ) represents a liability for the monetary institutions ( $-H$ ). Government issues debt ( $-B$ ) that is accumulated by two domestic sectors (i.e., households and central banks) and the external sector; households allocate their wealth to diversify their four-asset portfolios (local treasury bills, money, deposits, and structured notes), while the domestic central bank buys the portion of  $B$  that does not go to the household sector—in practice, the domestic central bank steps in to absorb the gap between the supply of and demand for domestic bills. This representation does not allow for unsold securities in the market. Central banks also accumulate foreign bonds as strategic reserves; however, as the dollar is the reserve currency due to the so-called hierarchy of currency (Kaltenbrunner 2015), the US central bank only needs to hold domestic bills, while the MX central bank holds domestic and foreign bills as reserves. As a result, there is an asymmetry in the central banks' profits.

Moreover, consumption ( $C$ ), government expenditure ( $G$ ), trade (imports [ $M$ ] minus exports [ $X$ ]), and taxes ( $T$ ) compose total income ( $Y$ ). It is entirely distributed to households in the form of total income ( $Y^{US}, Y^{LA}$ ). Households receive income ( $Y^{LA}$ ) from the production sector plus profits from the local financial intermediaries. They also receive interest payments on the stock of securities previously accumulated. They report two outflows, namely, consumption (which feeds back to the production sector) and government taxes (which are an inflow for the government). In this sense, we are considering a type of income defined as Haig-Simons (Godley and Lavoie 2006), that is, income does not only come from the real sector but also takes into account the revaluation of net worth and the payment of interest that households experience.

**Table 2. Transaction Flow Matrix**

		\$					#						
		Households	Production	Financial sector	Government	Central bank	\$	Households	Production	Financial sector	Government	Central bank	$\Sigma$
Consumption		- C	+ C				xr\$	- C	+ C				0
Government expenditures			+ G		- G		xr\$		+ G		- G		0
Trade			-IM				xr\$		+X				0
			+X				xr\$		-IM				0
Taxes		- T			+ T		xr\$	- T			+ T		0
GDP		+ Y <sub>\$</sub>	- Y <sub>\$</sub>				xr\$	+ Y <sub>#</sub>	- Y <sub>#</sub>				0
Financial sector profits		+ Fb		- Fb			xr\$	+ Fb		- Fb			0
Central bank profits					+ Fcb	- Fcb	xr\$				+ Fcb	- Fcb	0
Interest on	Deposits	+ r <sub>d-1</sub> .D <sub>-1</sub>		- r <sub>d-1</sub> .D <sub>-1</sub>			xr\$	+ r <sub>d-1</sub> .D <sub>-1</sub>		- r <sub>d-1</sub> .D <sub>-1</sub>			0
	Corporate Bills\$		- r <sub>c#-1</sub> .Bc# <sub>\$-1</sub>				xr\$			+ r <sub>c#-1</sub> .Bc# <sub>\$-1</sub>			0
	Corporate Bills#			+ r <sub>c\$-1</sub> .Bc# <sub>\$-1</sub>			xr\$		- r <sub>c\$-1</sub> .Bc# <sub>\$-1</sub>				0
	Treasury bills#			+ r <sub>b#-1</sub> .B# <sub>-1</sub>			xr\$	+ r <sub>b#-1</sub> .B# <sub>-1</sub>		+ r <sub>b#-1</sub> .B# <sub>-1</sub>	- r <sub>b#-1</sub> .B# <sub>-1</sub>	+ r <sub>b#-1</sub> .B <sub>cb#-1</sub>	0
	Treasury bills\$	+ r <sub>b\$-1</sub> .B# <sub>\$-1</sub>			- r <sub>b\$-1</sub> .B# <sub>\$-1</sub>	+ r <sub>b\$-1</sub> .B <sub>cb\$-1</sub>	xr\$			+ r <sub>b\$-1</sub> .B# <sub>\$-1</sub>		+ r <sub>b\$-1</sub> .B <sub>cb#-1</sub>	0
	Derivatives						xr\$	+ r <sub>cba-1</sub> .DER <sub>-1</sub>		- r <sub>cba-1</sub> .DER <sub>-1</sub>			0
	CBA\$	+ r <sub>cba-1</sub> .CBA <sub>-1</sub>		- r <sub>cba-1</sub> .CBA <sub>-1</sub>			xr\$						0
Change in the	Deposits	+ ΔD <sub>h</sub>		- ΔD			xr\$	+ ΔD <sub>h</sub>		- ΔD			0
stocks of	Corporate Bills\$		+ΔBc#				xr\$			-ΔBc#			0
	Corporate Bills#			-ΔBc#			xr\$		+ΔBc#				0
	Treasury bills#			+ ΔBb#			xr\$	+ ΔBh#		+ ΔBb#	- ΔB#	+ ΔBcb#	0
	Treasury bills\$	+ ΔBh\$		+ ΔBb\$	- ΔB\$	+ ΔBcb\$	xr\$			+ ΔBh#\$		+ ΔBcb#\$	0
	Derivatives						xr\$	+ ΔpDER <sub>h</sub>		- ΔpDER <sub>h</sub>			0
	CBA\$	+ ΔpCBA <sub>h</sub>		- ΔpCBA <sub>h</sub>			xr\$						0
	High-powered money	+ ΔH <sub>h</sub>				- ΔH	xr\$	+ ΔH <sub>h</sub>		+ ΔH <sub>b</sub>		- ΔH	0
$\Sigma$		0	0	0	0	0		0	0	0	0	0	0

In each period, firms and household pay taxes to the government, which represents a positive flow for the government—and for this reason  $G$  appears with a positive sign. The government is responsible for public spending to provide services to the entire economy. It could be the case that the government spends more than it collects ( $T - G < 0$ ). To do so, it issues bills ( $B$ ) to collect money from the public. Domestic bills are distributed to households in both countries.

The government pays interest ( $r^{MX}, r^{US}$ ) on debt previously issued ( $B_{-s(-1)}^{US}, B_{-s(-1)}^{MX}$ ). It is a positive inflow for holders (households, central banks, and the financial sectors). However, while households increase their total wealth with the profit received on the assets they hold, central banks and intermediaries return profits received on (domestic and foreign) bills. Having in mind how assets are allocated among sectors of both economies and how balance sheets and flows reciprocally feedback one into another, we can now summarize all the possible transactions in a flow diagram, which we report in table 3.

In formalizing the behavior of flows, stocks, and funds, we follow the structure proposed in Godley and Lavoie (2006), Lavoie and Daigle (2011), and Bonizzi (2015). The novelty of our equations concerns: a) the presence of a financial sector, which is in charge of the process of securitization of bills into new financial products, and b) the accumulation process by firms who financed their productive activities in excess of profits by issuing corporate securities.

We follow Godley and Lavoie (2006) and Lavoie and Daigle (2011) in considering the following variables as endogenous in the system: import prices, export prices, domestic sales deflators, GDP deflators and the exchange rate, exports, imports, output, consumption, domestic sales and disposable income, taxes, interest payments, the supply of money, holdings of foreign and domestic bills, holding of derivatives, household wealth, and the government deficit and debt.



**Table 3. Flow Diagram**

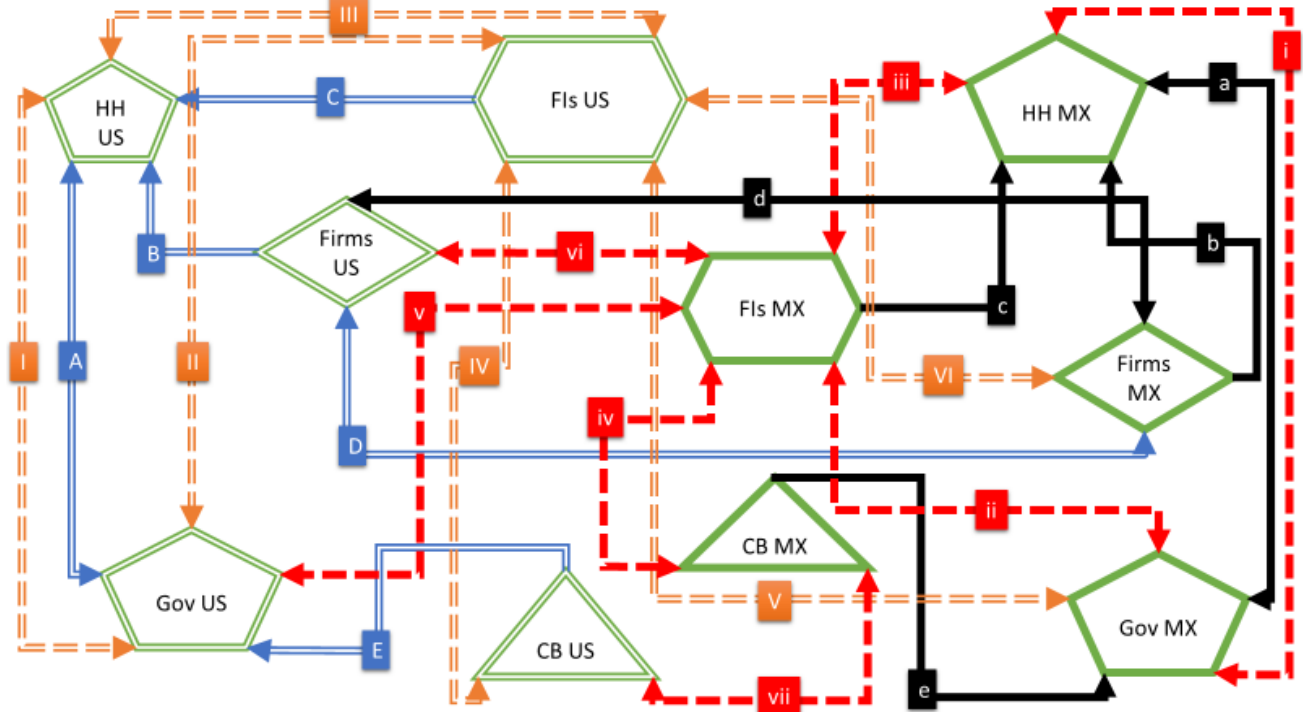

**Note:** Arrows into (out of) the boxes represent sources (uses) for a specific sector. Solid lines show nonfinancial transactions, while the dashed lines show flow-of-funds and interest payments. Upper- (lower-) case letters stand for US (MX) flows.

**Legend:** i) HPM and MX bills, MX households (HH); ii) HPM and MX bills, MX financial intermediaries (FIs); iii) structured notes, HH; iv) MX advances, MX central bank (CB); v) MX bills, US FIs; vi) MX corporate securities, US FIs; vii) US bills, MX CB; a) net government spending, MX HH; b) output, MX HH; c) FIs dividends, MX HH; d) net exports, MX firms; e) CB profits, MX government

### 3.1 Arterial Flows

Equations (1) and (2) describe the disposable income identities in both countries, which are obtained from the columns of the transaction flows matrix in table 3. Regular disposable income is total income plus capital gains (adopting the Haig-Simon convention), plus returns on assets. This equation, differently from Lavoie and Daigle (2011) and Lavoie (2006), is enlarged with a new asset, CBAs.

The presence of financial assets in the disposable income equation links aggregate income to the behavior of financial products. When the price of these assets increases (decreases), the economy will be better off (worse off) because of additional capital gains (losses). Capital gains are described in equations (5) and (6); they are calculated through accounting for variations in the price of the CBA,  $\Delta p_{cba}$ , on the price of accumulated stock of the asset,  $CBA_{s(-1)}$ .

The part of income not consumed ( $YD - C$ ) increases the net wealth. Equations (3) and (4) describe how the accumulation of wealth ( $\Delta V$ ) by the household sector is done through savings. Households pay taxes to the government on their regular income. Equations (9) and (10) describe the taxable income. They imply a fixed tax rate,  $\theta < 1$ , which is exogenously given by the government. Notice that the government in this case does not tax capital gains.

Columns 5 and 10 of the balance sheet show that central banks receive interest payments for the bills they hold. The US dollar is the reserve currency, thus, the US central bank only needs to hold domestic bills, while the MX central bank holds domestic and foreign bills as reserves. As a result, there is an asymmetry in the central banks' profits (equations [13] and [14]):  $F_{cb}^{US}$  only includes interest payments on local bills. As in Godley and Lavoie (2006), the model assumes that central banks have only the function of providing liquidity so that the profits generated by holding securities are given back to the government to relax its budget constraint, (equations [15] and [16]), as stated in columns 3 and 8 in the transaction flow matrix.

Government spending (equations [15] and [16]) needs to not exceed the budget constraint. When government expenditures exceed revenues—that is, when there is a primary budget deficit—it issues more domestic bills. The stock of debt issued by the government generates outflows for interest payments on the sectors that hold bills—households, the foreign sector, and domestic central banks.

The arterial flows that correspond to the balance of payment are obtained from rows 3 and 6 of the transaction flow matrix. The trade balance and the interest on bills received from and paid to the foreign country compose the current account balance ( $CAB$ ). Equations (17) through (19) capture this identity. The capital account ( $KAB$ ) (equations [18] through [20]) tracks the variation in flows due to the bond market and exchange rate revaluations. Notice that these equations are not specified in the matrices presented in the previous sector. However, they can be derived due to the principle of consistency (Godley and Lavoie 2006; Nikiforos and Zezza 2017).

*Disposable income*

$$(1) \quad YD^{US} = (Y^{US} + Fb^{US} + r_{(-1)}^{US} * B_{US\_d(-1)}^{US} + rd_{(-1)}^{US} * D_{d(-1)}^{US} + CBA_{d(-1)} + CG^{US} + CG_b^{US} + CG_c^{US}) * (1 - \theta^{US})$$

$$(2) \quad YD^{MX} = (Y^{MX} + Fb^{MX} + r_{(-1)}^{MX} * B_{LA\_d(-1)}^{MX} + rd_{(-1)}^{MX} * D_{d(-1)}^{MX} + DER_{d(-1)} + CG^{MX} + CG_b^{MX} + CG_c^{MX}) * (1 - \theta^{MX})$$

*Wealth*

$$(3) \quad \Delta V^{US} = YD^{US} - C^{US}$$

$$(4) \quad \Delta V^{MX} = YD^{MX} - C^{MX}$$

*Capital gains*

$$(5) \quad CG^{US} = (\Delta p_{cba}) * CBA_{s(-1)}$$

$$(6) \quad CG^{MX} = (\Delta p_{der}) * DER_{s(-1)}$$

*Demand for cash*

$$(7) \quad H_{d}^{US} = V^{US} - B_{US\_d}^{US} - D_{d}^{US} - P_{cba} * CBA_{d}$$

$$(8) \quad H_{d}^{MX} = V^{MX} - B_{MX\_d}^{MX} - D_{d}^{MX} - P_{der} * DER_{d}$$

*Tax*

$$(9) \quad T^{US} = (Y^{US} + Fb^{US} + r_{(-1)}^{US} * B_{US\_d(-1)}^{US} + rd_{(-1)}^{US} * D_{d(-1)}^{US} + CBA_{d(-1)}) * (\theta^{US})$$

$$(10) \quad T^{MX} = (Y^{MX} + Fb^{MX} + r_{(-1)}^{MX} * B_{MX\_d(-1)}^{MX} + rd_{(-1)}^{MX} * D_{d(-1)}^{MX} + DER_{d(-1)}) * (\theta^{MX})$$

*Central bank*

$$(11) \quad (\Delta B_{cbUS\_d}^{US}) = (\Delta H_{s}^{US}) + (\Delta H_{b\_s}^{US})$$

$$(12) \quad (\Delta B_{cbMX\_d}^{MX}) = (\Delta H_{s}^{MX}) + (\Delta H_{b\_s}^{MX}) - (\Delta B_{cbMX\_d}^{US}) * xr^{US}$$

$$(13) \quad F_{cb}^{MX} = r_{(-1)}^{MX} * Bcb_{MX\_d(-1)}^{MX} + r_{(-1)}^{US} * Bcb_{MX\_s(-1)}^{US} * xr^{US}$$

$$(14) \quad F_{cb}^{US} = r_{(-1)}^{US} * Bcb_{US\_d(-1)}^{US}$$

*Government budget constraint*

$$(15) \quad (\Delta B_{-s}^{US}) = G^{US} - T^{US} + r_{(-1)}^{US} * B_{-s(-1)}^{US} - Fcb^{US}$$

$$(16) \quad (\Delta B_{-s}^{MX}) = G^{MX} - T^{MX} + r_{(-1)}^{MX} * B_{-s(-1)}^{MX} - Fcb^{MX}$$

*Current and capital account*

$$(17) \quad CAB^{MX} = X^{MX} - IM^{MX} - r_{(-1)}^{MX} * B_{bUS_s(-1)}^{MX} - r_{c(-1)}^{MX} * B_{cUS_s(-1)}^{MX} + r_{(-1)}^{US} * B_{bMX_s(-1)}^{US} * xr^{US} + r_{c(-1)}^{US} * B_{cMX_s(-1)}^{US} * xr^{US} + r_{(-1)}^{US} * B_{cbMX_s(-1)}^{US} * xr^{US}$$

$$(18) \quad KAB^{MX} = (\Delta B_{bUS_s}^{MX}) + (\Delta B_{cUS_s}^{MX}) - (\Delta B_{cbMX_s}^{US}) * xr^{US} - (\Delta B_{bMX_s}^{US}) * xr^{US} - (\Delta B_{cMX_s}^{US}) * xr^{US}$$

$$(19) \quad CAB^{US} = X^{US} - IM^{US} - r_{(-1)}^{US} * B_{bMX}^{US} - r_{c(-1)}^{US} * B_{cMX}^{US} + r_{(-1)}^{MX} * B_{bUS_s(-1)}^{MX} * xr^{MX} + r_{c(-1)}^{MX} * B_{cUS_s(-1)}^{MX} * xr^{MX} - r_{(-1)}^{MX} * B_{cbUS_s(-1)}^{MX} * xr^{MX}$$

$$(20) \quad KAB^{US} = (\Delta B_{bMX_s}^{US}) + (\Delta B_{cMX_s}^{US}) - (\Delta B_{cbUS_s}^{MX}) * xr^{MX} - (\Delta B_{bUS_s}^{MX}) * xr^{MX} - (\Delta B_{cUS_s}^{MX}) * xr^{MX}$$

### 3.2 Trade

This section describes trade between countries. Equations (21) through (32) formalize the relations among prices and quantities of goods and services exchanged between MX and the US. Trade depends on a set of prices and elasticity to changes in prices and income.

Trade flows are measured in real terms, as shown in equations (21) and (22)—variables in bold are natural logarithms, a transformation that allows us to introduce elasticity. The volume of exports ( $\mathbf{x}^{MX}$ ) depends on the elasticity ( $\eta^{MX}$ ) to prices and the elasticity to income ( $\varepsilon^{MX}$ ). Similarly, volume of imports ( $\mathbf{m}^{MX}$ ) depends on the elasticity to domestic income and domestic and foreign prices

Equation 23 states that export prices for MX depend on the exogenous component ( $\chi_0^{US}$ ), and on the elasticity to the exchange rate, domestic prices, and foreign prices. Symmetrically, equation (24) states the relation that import prices depend on their elasticity to domestic and foreign prices, as well with the exchange rate.

Prices between countries are symmetric, that is, import prices for MX equal export prices for the US, adjusted by the exchange rate (equations [25] and [26]). Rows 3 and 6 in the transaction flow matrix impose the consistency requirement that quantities of imports for the US correspond to export prices and volumes for MX, and vice versa (equations [27] and [28]). Finally, flows are expressed in real terms (equations [29] through [32]).

#### *Export and import real quantities*

$$(21) \quad x^{MX} = \epsilon^{MX} - \eta^{MX} * (p_{m-1}^{US} - p_{y-1}^{US}) + \varepsilon^{MX} * y^{US}$$

$$(22) \quad m^{MX} = \varrho^{MX} - \psi^{MX} * (p_{m-1}^{MX} - p_{y-1}^{MX}) + \pi^{MX} * y^{US}$$

$$(23) \quad p_x^{MX} = \chi_0^{MX} + \chi_1^{MX} * p_y^{US} + (1 - \chi_1^{MX}) * p_y^{LA} - \chi_1^{MX} * x r^{MX}$$

$$(24) \quad p_m^{MX} = \mu_0^{MX} + \mu_1^{MX} * p_y^{US} + (1 - \mu_1^{MX}) * p_y^{LA} - \mu_1^{MX} * x r^{MX}$$

#### *Export and import prices*

$$(25) \quad p_x^{US} = p_m^{MX} * x r^{MX}$$

$$(26) \quad p_m^{US} = p_x^{MX} * x r^{MX}$$

$$(27) \quad x^{US} = m^{MX}$$

$$(28) \quad m^{US} = x^{MX}$$

$$(29) \quad X^{MX} = x^{MX} * p_x^{MX}$$

$$(30) \quad X^{US} = x^{US} * p_x^{US}$$

$$(31) \quad IM^{MX} = m^{MX} * p_m^{MX}$$

$$(32) \quad IM^{US} = m^{US} * p_m^{US}$$

### **3.3 Income and Price Determination**

The income and price determination block closely follows the one defined in Godley and Lavoie (2006) and Zezza and Dos Santos (2006). Again, real and nominal values are in lower- and uppercase, respectively, while the superscripts depict the nationality. Real disposable income is of the Haig-Simon type—i.e., gross of any inflation loss.

Real sales are the sum of the domestic sales—household and government consumption—plus real exports to the external sector, adjusted for the level of prices.

Sales volume ( $s^{US}$ ) represents the sum of consumption, government spending, and exports.

To obtain the sales values ( $S^{US}$ ), sales volume is multiplied by sales prices ( $p_s^{US}$ ), which, in turn, is obtained by adding a markup ( $\varphi^{US}$ ) to unit costs ( $\frac{(W^{MX} * N^{MX} + IM^{MX} + r_{c(-1)}^{MX} * B_{cs(-1)}^{MX} * \chi r^{MX})}{s^{MX}}$ ). Finally, the price of domestic sales ( $p_s^{MX}$ ) is the ratio between sales and import prices between the two countries.

Both nominal wages and markups are assumed to adjust to past inflation according to the parameters ( $\Omega^{US}$ ,  $\Omega^{MX}$ ) and ( $\Phi^{US}$ ,  $\Phi^{MX}$ ), which are meant to capture the bargaining power of workers and the degree of monopoly of firms, respectively. They also depend on an exogenous component,  $W_0^{MX}(W_0^{US})$  and  $\varphi_0^{MX}(\varphi_0^{US})$

Therefore, the domestic output (both real and nominal) is defined as sales minus imports (equations [69] through [72]), with the GDP deflator being simply the ratio between nominal and real output (equations [73] and [74]).

The stock of wealth is measured in real terms ( $v$ ); it is adjusted for the price of domestic sales ( $p_{ds}$ ). Also, disposable income can be expressed in real terms ( $yd$ ) by carefully adjusting the lagged stock of wealth to the inflation accumulated in the last period.

Real consumption (equations [49–50]) depends on expected real disposable income ( $yd_e$ ) and the stock of wealth accumulated by households. Expected disposable income (equations [51] and [52]) is assumed to be a simple average based on the past value of income.

Notice that beside the wage bill ( $W^{MX} * N^{MX}$ ) and imports ( $IM^{MX}$ ), interest payment on foreign debt are also considered within firms' unit costs, in line with Bortz (2014) and as it appears from equations (37) and (38). Hence, profit margins are directly influenced by the balance sheet effect.

After having defined prices and quantity of sales, it is possible to define the domestic sales value, domestic sales volume, nominal GDP, real GDP, GDP deflator, value of consumption, value of government expenditure, and tax yield. This is done through simple identities.

*Basic accounting identities in an open economy*

- $$(33) \quad s^{MX} = c^{MX} + g^{MX} + x^{MX}$$
- $$(34) \quad s^{US} = c^{US} + g^{US} + x^{US}$$
- $$(35) \quad S^{MX} = s^{MX} * p_s^{MX}$$
- $$(36) \quad S^{US} = s^{US} * p_s^{US}$$
- $$(37) \quad p_s^{MX} = \frac{(1+\varphi^{MX}) * (W^{MX} * N^{MX} + IM^{MX} + r_{c(-1)}^{MX} * B_{c_s(-1)}^{MX}) * x r^{MX}}{s^{MX}}$$
- $$(38) \quad p_s^{US} = \frac{(1+\varphi^{US}) * (W^{US} * N^{US} + IM^{US} + r_{c(-1)}^{US} * B_{c_s(-1)}^{US}) * x r^{US}}{s^{US}}$$
- $$(39) \quad p_{ds}^{MX} = \frac{(s^{MX} - x^{MX})}{(s^{MX} - x^{MX})}$$
- $$(40) \quad p_{ds}^{US} = \frac{(s^{US} - x^{US})}{(s^{US} - x^{US})}$$
- $$(41) \quad Y^{MX} = S^{MX} - IM^{MX}$$
- $$(42) \quad Y^{US} = S^{US} - IM^{US}$$
- $$(43) \quad y^{MX} = s^{MX} - m^{MX}$$
- $$(44) \quad y^{US} = s^{US} - m^{US}$$
- $$(45) \quad v^{MX} = \frac{v^{MX}}{p_{ds}^{MX}}$$
- $$(46) \quad v^{US} = \frac{v^{US}}{p_{ds}^{US}}$$
- $$(47) \quad yd^{MX} = \frac{YD^{MX}}{p_{ds}^{MX}} - v_{(-1)}^{MX} * \frac{\Delta p_{ds}^{MX}}{p_{ds}^{MX}}$$
- $$(48) \quad yd^{US} = \frac{YD^{US}}{p_{ds}^{US}} - v_{(-1)}^{US} * \frac{\Delta p_{ds}^{US}}{p_{ds}^{US}}$$
- $$(49) \quad c^{MX} = \alpha_1^{MX} * yd_e^{MX} + \alpha_2^{MX} * v_{(-1)}^{MX}$$
- $$(50) \quad c^{MX} = \alpha_1^{MX} * yd_e^{MX} + \alpha_2^{MX} * v_{(-1)}^{MX}$$
- $$(51) \quad yd_e^{MX} = \frac{yd^{MX} + yd_{(-1)}^{MX}}{2}$$
- $$(52) \quad yd_e^{\$} = \frac{yd^{\$} + yd_{(-1)}^{\$}}{2}$$
- $$(53) \quad infl^{US} = p_y^{US} / p_{y(-1)}^{US} - 1$$
- $$(54) \quad infl^{MX} = p_y^{MX} / p_{y(-1)}^{MX} - 1$$
- $$(55) \quad W^{US} = W_0^{US} + W_{(-1)}^{US} * (1 + inflW^{US})$$
- $$(56) \quad W^{MX} = W_0^{MX} + W_{(-1)}^{MX} * (1 + inflW^{MX})$$

$$\begin{aligned}
(57) \quad & inflW^{US} = \Omega^{US} * (infl_{(-1)}^{US}) \\
(58) \quad & inflW^{MX} = \Omega^{MX} * (infl_{(-1)}^{MX}) \\
(59) \quad & \varphi^{US} = \varphi_0^{US} + \varphi_{(-1)}^{US} * (1 + infl\varphi^{US}) \\
(60) \quad & \varphi^{MX} = \varphi_0^{MX} + \varphi_{(-1)}^{MX} * (1 + infl\varphi^{MX}) \\
(61) \quad & infl\varphi^{US} = \Phi^{US} * (infl_{(-1)}^{US}) \\
(62) \quad & infl\varphi^{MX} = \Phi^{MX} * (infl_{(-1)}^{MX}) \\
(63) \quad & DS^{MX} = S^{MX} - X^{MX} \\
(64) \quad & DS^{US} = S^{US} - X^{US} \\
(65) \quad & ds^{MX} = c^{MX} + g^{MX} \\
(66) \quad & ds^{US} = c^{US} + g^{US} \\
(67) \quad & Y^{MX} = S^{MX} - IM^{MX} \\
(68) \quad & Y^{US} = S^{US} - IM^{US} \\
(69) \quad & y^{MX} = s^{MX} - m^{MX} \\
(70) \quad & y^{US} = s^{US} - m^{US} \\
(71) \quad & p_y^{MX} = \frac{Y^{MX}}{y^{MX}} \\
(72) \quad & p_y^{US} = \frac{Y^{US}}{y^{US}} \\
(73) \quad & C^{MX} = c^{MX} * p_{ds}^{MX} \\
(74) \quad & C^{US} = c^{US} * p_{ds}^{US} \\
(75) \quad & G^{MX} = g^{MX} * p_{ds}^{MX} \\
(76) \quad & G^{US} = g^{US} * p_{ds}^{US}
\end{aligned}$$

### 3.4 Financial Intermediaries

The financial sector of both countries works in a similar way, except for the equations describing the behavior of the two structured assets, namely the CBA (issued by the intermediaries in the US) and the DER (issued by the intermediaries in the MX) in a similar way as Nalin and Yajima (2019). The flow of funds in columns 3 and 8 define the quantity of bills demanded by the domestic US/MX financial sector ( $B_{b,d}^{US}, B_{b,d}^{MX}$ ). It is calculated as a residual of the quantity of wealth not allocated in deposits or foreign bills—we report it in equations (78) and (88). The demand for high-powered money by the intermediaries ( $H_{b,d}^{US}$ ) corresponds to a fraction of total deposits (equations



[78] and [88]). Similarly, the demand for foreign bills corresponds to a fraction of the structured notes ( $CBA_{_s}$ ,  $DER$ ) issued by the financial sectors and distributed to local households.

We assume that the demand for foreign corporate securities (equations [80] through [90]) always matches its own supply multiplied by the exchange rate. Interest paid on demand deposits, corporate securities, foreign bills, and capital gains (losses) on exchange rate appreciation (depreciation) compose the total profits of the financial sector (equations [86] through [96]). Notice that the deposit rates (equations [81] through [91]) comove with the local policy rate—i.e., the rate on government bills—while the rates on securities (equations [82] through [92]) follow the behavior of the foreign policy rate plus a premium.

#### *US financial sector*

$$(77) \quad B_{bd}^{US} = D_s^{US} - B_{bUSd}^{MX} - H_{bd}^{US} - B_{cUS_s}^{MX} + P_{cba} * CBA_s + A_s^{US}$$

$$(78) \quad H_{bd}^{US} = \rho_0^{US} * D_s^{US}$$

$$(79) \quad B_{bUS_d}^{MX} = \rho_1^{US} * CBA_{_s}$$

$$(80) \quad B_{cd}^{US} = B_{cs}^{US} * xr^{US}$$

$$(81) \quad \Delta r_d^{US} = \rho_2^{US} * \Delta r^{US}$$

$$(82) \quad r_c^{MX} = (1 + \rho_3^{US}) * r^{US}$$

$$(83) \quad P_{cba} = \frac{1}{r_{cba}} + p_x^{MX}$$

$$(84) \quad CG_b^{US} = (\Delta xr^{MX}) * B_{bUS_s(-1)}^{MX}$$

$$(85) \quad CG_c^{US} = (\Delta xr^{MX}) * B_{cUS_s(-1)}^{MX}$$

$$(86) \quad F_b^{US} = r_{(-1)}^{US} * B_{bd(-1)}^{US} - r_d^{US} * D_{s(-1)}^{US} + r_{(-1)}^{MX} * B_{bUS_d(-1)}^{MX} * xr^{MX} + CG_b^{US} - CBA_{_s(-1)} - r_{A(-1)}^{US} * A_{_s(-1)}^{US}$$

#### *MX financial sector*

$$(87) \quad B_{bd}^{MX} = D_s^{MX} - B_{bMXd}^{US} - H_{bd}^{MX} - B_{cMX_s}^{US} + P_{der} * DER_s + A_s^{MX}$$

$$(88) \quad H_{bd}^{MX} = \rho_0^{MX} * D_s^{MX}$$

$$(89) \quad B_{bMX_d}^{US} = \rho_1^{MX} * DER_{_s}$$

$$(90) \quad B_{cd}^{MX} = B_{cs}^{MX} * xr^{MX}$$

$$\begin{aligned}
(91) \quad \Delta r_d^{MX} &= \rho_2^{MX} * \Delta r^{MX} \\
(92) \quad r_c^{US} &= (1 + \rho_3^{MX}) * r^{MX} \\
(93) \quad P_{der} &= \frac{1}{r_{der}} \\
(94) \quad CG_b^{MX} &= (\Delta x r^{US}) * B_{bMX_s(-1)}^{US} \\
(95) \quad CG_c^{MX} &= (\Delta x r^{US}) * B_{cMX_s(-1)}^{US} \\
(96) \quad F_b^{MX} &= r_{(-1)}^{MX} * B_{b_d(-1)}^{MX} - r_d^{MX} * D_{s(-1)}^{MX} + r_{(-1)}^{US} * B_{bMX_d(-1)}^{US} * x r^{US} + CG_b^{MX} - \\
&DER_{s(-1)} - r_{A(-1)}^{MX} * A_{s(-1)}^{MX}
\end{aligned}$$

### 3.5 Firms' Capital Accumulation and Financing

The decision of firms to accumulate capital stock follows the accelerator mechanism based on Harrod (1939) and Domar (1946), in line with Godley and Lavoie (2006) and Bortz (2014). The current capital stock is made up of the stock accumulated in the past period net of depreciation and augmented with the demand for investment. The latter depends upon the discrepancy between the targeted amount of capital firms want to accumulate in order to meet current demand and the capital stock previously accumulated—i.e., if current capital is less than the target, then firms will invest to match demand. In other words, the targeted amount of capital is a function of nominal output—gross of depreciation allowance—in the sense that growing demand puts upward pressure on the capital target.

The novelty of the model is in the way the process of capital accumulation is financed. As in Kalecki (1971), we consider that firms have two ways to finance investment, namely, internal funding (reinvestment of profits) or external resources (debt issuance). When profits are not enough to finance the desired level of investment, firms decide to cover the gap by issuing corporate securities sold to foreign financial intermediaries.

The nonfinancial sector in emerging economies has increasingly relied on upon international fixed income markets at the expense of demand for loans (Chui, Kuruc, and Turner 2016). Since these liabilities are denominated in foreign currency, their value depends upon the exchange rate and the capital losses (gains) deriving from its depreciation (appreciation). Hence, in equations (97) through

(105), it is possible to see how firms' profits are exposed to the balance sheet effect predicted by Céspedes, Chang, and Velasco (2004).

The effect generated by exchange rate fluctuations also needs to consider the revaluation in the value of imports. Indeed, imports weight on revenues, as the nominal output is composed by sales minus imported goods. Accordingly, the exchange rate influences reinvested profits also from the traditional production side via higher import prices (Krugman and Taylor 1978), beside the external debt channel abovementioned. Finally, firms hire workers in accordance with a target between actual and desired employment (equations [98] through [106]), the latter being nominal output over labor productivity (equations [99] through [107]), which in this model is set exogenously.

*US firms*

$$(97) \quad F_c^{US} = Y^{US} - W^{US} * N^{US} - r_{c(-1)}^{US} * B_{c_s(-1)}^{US} * xr^{US} - DA^{US} - CG_c^{MX}$$

$$(98) \quad N^{US} = N_{(-1)}^{US} + \zeta^{US} * (N_T^{US} - N_{(-1)}^{US})$$

$$(99) \quad N_T^{US} = \frac{y^{US}}{pr^{US}}$$

$$(100) \quad \Delta B_{c_d(-1)}^{US} = I_d^{US} - F_{c(-1)}^{US}$$

$$(101) \quad K^{US} = K_{(-1)}^{US} + I_d^{US} - DA^{US}$$

$$(102) \quad DA^{US} = \delta^{US} * K_{(-1)}^{US}$$

$$(103) \quad K_T^{US} = \kappa^{US} * Y_{(-1)}^{US}$$

$$(104) \quad I_{-d}^{US} = \gamma^{US} * (K_T^{US} - K_{(-1)}^{US}) + DA^{US}$$

*MX firms*

$$(105) \quad F_c^{MX} = Y^{MX} - W^{MX} * N^{MX} - r_{cUS(-1)}^{MX} * B_{cUS_s(-1)}^{MX} * xr^{MX} - DA^{MX} - CG_c^{US}$$

$$(106) \quad N^{MX} = N_{(-1)}^{MX} + \zeta^{MX} * (N_T^{MX} - N_{(-1)}^{MX})$$

$$(107) \quad N_T^{MX} = \frac{y^{MX}}{pr^{MX}}$$

$$(108) \quad \Delta B_{c_d(-1)}^{MX} = I_d^{MX} - F_{c(-1)}^{MX}$$

$$(109) \quad K^{MX} = K_{(-1)}^{MX} + I_d^{MX} - DA^{MX}$$

$$(110) \quad DA^{MX} = \delta^{MX} * K_{(-1)}^{MX}$$

$$(111) \quad K_{-T}^{MX} = \kappa^{MX} * Y_{(-1)}^{MX}$$

$$(112) \quad I_{-d}^{MX} = \gamma^{MX} * (K_{-T}^{MX} - K_{(-1)}^{MX}) + DA^{MX}$$

### 3.6 Asset Demand and Supply and Exchange Rate Closure

Table 3 shows that US residents' demand for assets is given by the demand for deposits, domestic bonds, and CBAs. US residents receive  $r^{US}, r_d^{US}, r_{cba}$  on deposits, domestic bills, and CBAs. MX residents' portfolio is composed of deposits, domestic bills, and DER, paying  $r_d^{MX}, r^{MX}, r_{der}$ , respectively. According to columns 1 and 5, savings ( $Yd - C$ ) in each period increase wealth. Households allocate their wealth among assets. This is reported in the matrix portfolios depending on expectations on yields and preference (equations [113] and [114]). The model assumes, in line with Godley and Lavoie (2006), the supply of assets equals demand. Equations (115) through (130) show all the identities for the several asset classes used in the model. Moreover, changes in central banks' stocks of domestic Treasury bills are equal to changes in the liabilities of each central bank, as shown in equations (98) and (98). Once again, the equation for the MX central bank is enlarged with foreign bills held as reserves.

Having defined all the equations for both countries, it is now possible to close the model using the exchange rate. A common assumption is that the central bank buys any quantity of government liabilities that are not demanded by the private sector and supplies an amount of HPM equal to its demand (Nikiforos and Zezza 2017). Hence, the amount of foreign reserves, measured in dollars, becomes a constant. US bills supplied to foreign bondholders are a residual, i.e., the residual between the total amount of bills and the sectorial demand for bills (equations [110] and [112]). Higher (lower) demand for bills appreciates (depreciate) the exchange rate—the so-called quantity notation.

Notice that equation (134) implies an upward (downward) movement for appreciation (depreciation).

The reader could argue that this closure makes the nominal exchange rate only dependent upon the supply and demand for foreign assets; however, this could be a misleading interpretation, since the model is a fully interdependent one. Consider for instance foreign bills' demand: this would depend

on how much “leverage” intermediaries could make in issuing their structured papers, which in turn would depend on households’ wealth, income, and so on. This is the essence of the financial view on the exchange rate adopted by our work and based on stylized facts for Mexico; it means, considering explicitly money and financial transactions among the determinants of the exchange rate.

*Asset demand for MX residents<sup>3</sup>*

$$(113) \quad \begin{bmatrix} B_{MX\_d}^{MX} \\ D_{-d}^{MX} \\ P_{der} * DER_{-s} \end{bmatrix} = \begin{bmatrix} \lambda_{10}^{MX} \\ \lambda_{20}^{MX} \\ \lambda_{30}^{MX} \end{bmatrix} * V^{\#} + \begin{bmatrix} \lambda_{11}^{MX} & \lambda_{12}^{MX} & \lambda_{13}^{MX} \\ \lambda_{21}^{MX} & \lambda_{22}^{MX} & \lambda_{23}^{MX} \\ \lambda_{31}^{MX} & \lambda_{32}^{MX} & \lambda_{33}^{MX} \end{bmatrix} * \begin{bmatrix} r^{MX} \\ r_b \\ r_{fp} \end{bmatrix} * V^{MX}$$

*Asset demand for US residents*

$$(114) \quad \begin{bmatrix} B_{US\_d}^{US} \\ D_{-d}^{US} \\ P_{cba} * CBA_{-s} \end{bmatrix} = \begin{bmatrix} \lambda_{10}^{US} \\ \lambda_{20}^{US} \\ \lambda_{30}^{US} \end{bmatrix} * V^{\$} + \begin{bmatrix} \lambda_{11}^{US} & \lambda_{12}^{US} & \lambda_{13}^{US} \\ \lambda_{21}^{US} & \lambda_{22}^{US} & \lambda_{23}^{US} \\ \lambda_{31}^{US} & \lambda_{32}^{US} & \lambda_{33}^{US} \end{bmatrix} * \begin{bmatrix} r^{US} \\ r_d^{US} \\ r_{cba} \end{bmatrix} * V^{US}$$

*Supply of stocks equals demand*

$$(115) \quad H_{-s}^{US} = H_{-d}^{US}$$

$$(116) \quad H_{-s}^{MX} = H_{-d}^{MX}$$

$$(117) \quad A_{-s}^{US} = A_{-d}^{US}$$

$$(118) \quad A_{-s}^{MX} = A_{-d}^{MX}$$

$$(119) \quad D_{-s}^{US} = D_{-d}^{US}$$

$$(120) \quad D_{-s}^{MX} = D_{-d}^{MX}$$

$$(121) \quad B_{US\_s}^{US} = B_{US\_d}^{US}$$

$$(122) \quad B_{MX\_s}^{MX} = B_{MX\_d}^{MX}$$

$$(123) \quad CBA_{-s} = CBA_{-d}$$

$$(124) \quad DER_{-s} = DER_{-d}$$

---

<sup>3</sup> Each portfolio is composed of two elements, namely an exogenous vector ( $\lambda_{i0}$ ) and the response of assets to changes in yields ( $\lambda_{ik}$ ). According to Brainard and Tobin (1968), Tobin (1968, 1982), and Backus et al. (1980), for the vertical constraint to be realized it must be that  $\lambda_{10}^i + \lambda_{20}^i + \lambda_{30}^i = 1$  and  $\lambda_{1k}^i + \lambda_{2k}^i + \lambda_{3k}^i = 0$ , while the horizontal constraint implies  $\lambda_{j1}^i + \lambda_{j2}^i + \lambda_{j3}^i = 0$ .

$$(125) \quad B_{b_s}^{US} = B_{b_d}^{US}$$

$$(126) \quad B_{b_s}^{MX} = B_{b_d}^{MX}$$

$$(127) \quad H_{b_s}^{US} = H_{b_d}^{US}$$

$$(128) \quad H_{b_s}^{MX} = H_{b_d}^{MX}$$

$$(129) \quad B_{cbUS_s}^{US} = B_{cbUS_d}^{US}$$

$$(130) \quad B_{cbMX_s}^{MX} = B_{cbMX_d}^{MX}$$

*Exchange rate closure*

$$(131) \quad xr^{US} = \frac{1}{xr^{MX}}$$

$$(132) \quad B_{bUS_s}^{MX} = B_{bUS_d}^{MX} * xr^{US}$$

$$(133) \quad \Delta B_{cbMX_d}^{US} = \Delta B_{cbMX_s}^{US} * xr^{US}$$

$$(134) \quad xr^{MX} = \frac{B_{bMX_s}^{US}}{B_{bMX_d}^{US}}$$

$$(135) \quad B_{bMX_s}^{US} = B_s^{US} - B_{US_s}^{US} - B_{cb_d}^{US} - B_{cbMX_s}^{US} - B_{b_s}^{US}$$

$$(136) \quad B_{bMX_s}^{US} = \frac{B_{bMX_d}^{US}}{xr^{US}}$$

$$(137) \quad B_{bUS_s}^{MX} = B_s^{MX} - B_{MX_s}^{MX} - B_{cb_d}^{MX} - B_{b_s}^{MX}$$

$$(138) \quad B_{bUS_s}^{MX} = \frac{B_{bUS_d}^{MX}}{xr^{MX}}$$

$$(139) \quad RER^{MX} = xr^{MX} * \left( \frac{p_y^{MX}}{p_y^{US}} \right)$$

$$(140) \quad RER^{US} = xr^{US} * \left( \frac{p_y^{US}}{p_y^{MX}} \right)$$

In the short run, the system reaches “equilibrium” through price adjustments in financial markets, although this condition should not be seen as a state of rest, as long as the expectations that drive expenditure and portfolio decisions are not fulfilled and/or the stocks are not at their target level (Nikiforos and Zezza 2017).

## 4 MODEL CALIBRATION

Before proceeding with scenario analysis, we need to calibrate the model to include some important stylized facts and asymmetries between the MX and US economies. The choice of values for exogenous parameters and initial stocks determine the calibration of the model. Once this is done, a steady state is usually computed (Caverzasi and Godin 2013). The disadvantage is that in models this large, stability analysis becomes almost impossible, and one can only infer about it by reading actual tendencies and not by looking at mathematical conditions (Bortz 2014).

The reader should be reminded, though, that calibration does not intend to completely match the characteristics of either of these two countries, but rather a stylized interpretation of both economies. Scenario analysis needs not to be interpreted as a macroeconomic exercise to forecast trends in variables. Instead, the exercise consists of examining the impact of the shocks compared with the baseline scenario and evaluating how variables diverge from their baselines.

According to Carnevali et al. (2019), a model's coefficients can be: a) calibrated, based on stylized facts; ii) estimated through standard econometric techniques; or iii) fine-tuned in such a way to obtain a specific baseline scenario. For (i), Lavoie and Daigle (2011), and Bonizzi (2015) adopt the parameters from chapter 12 of Godley and Lavoie (2006), which are empirically estimated by Gennaro Zezza. Alternatively, practitioners selected values for (ii) from empirical estimations, such as Valdecantos and Zezza (2015). We adopt (iii), in which numerical values for the parameters are individuated, basing the choices on the observation of stylized facts. Thus, we borrowed most parameters from Godley and Lavoie (2006), although we make asymmetrical assumptions for the following three elements of the model, namely: i) the Marshall-Lerner (M-L) condition; ii) propensity to consume; and iii) labor productivity. For all, we adopt parameters based on the empirical literature.

### 4.1 Marshall-Lerner Condition

An important consideration for SFC concerns the relationship describing the dynamic between the RER and trade flows. In SFC modeling authors reject the fulfillment of the M-L condition. Still, they assume that a positive relationship with the RER might exist: "It is often assumed that the sum of the elasticities with respect to relative prices must sum to at least one if the trade balance is to improve following devaluation (the Marshall-Lerner condition). But in verity the sum of these

elasticities need be no greater than the elasticity of terms of trade with respect to devaluation” (Godley and Lavoie 2006, 453).

Recall equations (23) and (24) from section 3.2 for the price of exports. If the M-L condition were to apply, it would be  $\eta^{LA} + \psi^{LA} > 1$ , while in SFC modeling it turns to be (Carnevali et al. 2019, 2020):

$$\eta^{LA} * (1 - \chi_1^{LA}) + \psi^{LA} * \mu_1^{LA} > \mu_1^{LA} - \chi_1^{LA}$$

As a result, after a negative shock in the system, the currency depreciates, allowing the model to achieve a new steady-state equilibrium through the upward adjustment in exports favored by a competitive RER. In other words, the external sector is a buffer for the economy when a shock materializes.

To set parameters for trade elasticities, we review the empirical literature on the M-L condition in Mexico. Empirical studies for Mexico show contrasting results. López and Cruz (2000) find no evidence of the M-L condition for the period 1968–96. Goicoechea (2001) finds evidence for the period 1980Q1–2001Q2. In recent times, Cermeño and Rivera (2015) do not find convincing evidence on the M-L condition for the period 1994–2014, as only the income elasticity turns out to be statistically significant. Using balance-of-payments constraint analysis, Pacheco-Lopez and Thirwall (2004) and Pacheco-Lopez (2005) find that the M-L condition is barely satisfied for Mexico. Spinola (2020) estimates several vector error correction models (VECMs) to test the effect of the RER on the trade balance; he finds contrasting results, sensitive to econometric specifications.

Given the contrasting empirical evidence for the M-L condition in Mexico, we decide to use Carnevali’s parameters, which reject the M-L condition and construct generic parameters for simulations. We set both the price elasticity of exports and imports to 0.49 log (price import/infl). Notice, that the absolute value of the sum of each elasticity is 0.98, which is still close to unity. This setting allows us to consider a not fully M-L condition, but still close to it, in line with the findings of Pacheco-López and Thirwall (2004), Pacheco-López (2005) Cermeño and Rivera (2015), and Spinola (2020).



## 4.2 Propensity to Consume

Developed and developing countries are unlikely to show the same propensity to consume out of income (Funke 2004; Case, Quigley, and Shiller 2011; Gross, Notowidigdo, and Wang 2020).

Marginal propensity to consume out of income appears to be higher in developing countries than in developed ones, especially in the United States (Case, Quigley, and Shiller 2011). For the former, it is around 0.6 (Funke 2004), while for the latter 0.9 (Case, Quigley, and Shiller 2011). We adopt these values to model the different marginal propensities to consume between MX and US.

## 4.3 Labor Productivity

Acemoglu and Dell (2010) show that in the Americas there are differences between and within countries, especially when comparing Latin American countries with North American ones (the United States and Canada). Following their finding, we arbitrarily set a 30 percent difference in labor productivity between MX and US.

# 5 DESCRIPTION OF EXPERIMENT AND RESULTS

The episode used to evaluate the balance sheet effect on investment is the end of the commodity price boom. Commodity prices experienced an initial positive shock in 2004, followed by a drop in 2014. To model this, we impose a positive shock in the exogenous component of exports at the beginning of 2004. This is replicated by increasing the parameter  $\chi_0^{LA}$  in equation (21) for the period 2004–14; that is, we change from -2.2 to -.2 in the parameter of  $\chi_0^{LA}$ .

To calculate a proxy for the percentage change in the autonomous demand for exports, we looked at data for the volume of exports of crude oil, available in the central bank's database. We consider the variation in the autonomous demand as a long-run change. We use the five-year moving average of the series as a proxy for this value. We then calculate the percentage difference in December 2015 from one year later, which results in a 9 percent change in the long-run (autonomous) demand for exports and translates into a change from -1.18 to -1.08 in the parameter of  $\chi_0^{LA}$ .

Additionally, to model changes in international monetary policy, in 2009 we impose a decrease in the US interest rate from 3 percent to 2 percent. In 2014, we impose a symmetric shock that increases interest back to 3 percent.

Simulations run during 110 periods called “years,” starting from a fictional 1990 to 2100. Shocks were introduced in the “year” 2004, 2009, and 2014:

- 2004: Increase in exogenous demand for exports;
- 2009: Decrease in the US interest rate;
- 2014: Decrease in exogenous demand for exports;
- 2014: Increase in the US interest rate.

Initial values for stocks are set up mostly using Godley and Lavoie (2006) and are fictional; as a result, responses to shocks might be difficult to interpret. To have a better understanding of results, we normalize all the series according to their mean and standard deviations (SD). In this way, we can interpret results from shocks as the misalignment from the mean of the series, expressed in SDs.

The reader will notice that some initial values are not equal to zero. The interpretation of that is the following. A positive (negative) initial value implies that before the simulation, the variable has, on average, higher (lower) values than after the simulation (the coefficient of the SD indicates how much higher). That is, after the shock the variable reports, on average, lower (higher) values than the initial one. We report the simulation results in figure 1 through figure 5. We analyze the results in five blocks, with figure 1 representing the response from the RER, figure 2 from trade, figure 3 from public finances, figure 4 from redistribution, and figure 5 from the corporate sector.

### **5.1 Effect on the RER’s Trajectory**

Figure 1 reports estimations for the RER, which is calculated as the nominal exchange rate multiplied by the ratio between foreign and domestic prices. Being a system with only two countries, the RER is interpreted as a bilateral RER. Additionally, we report the CBA price, terms of trade (TOT)—that is, the ratio between export and import prices—and the stock of CBAs held by US investors.

**Figure 1. Responses from RER, CBA, TOT**

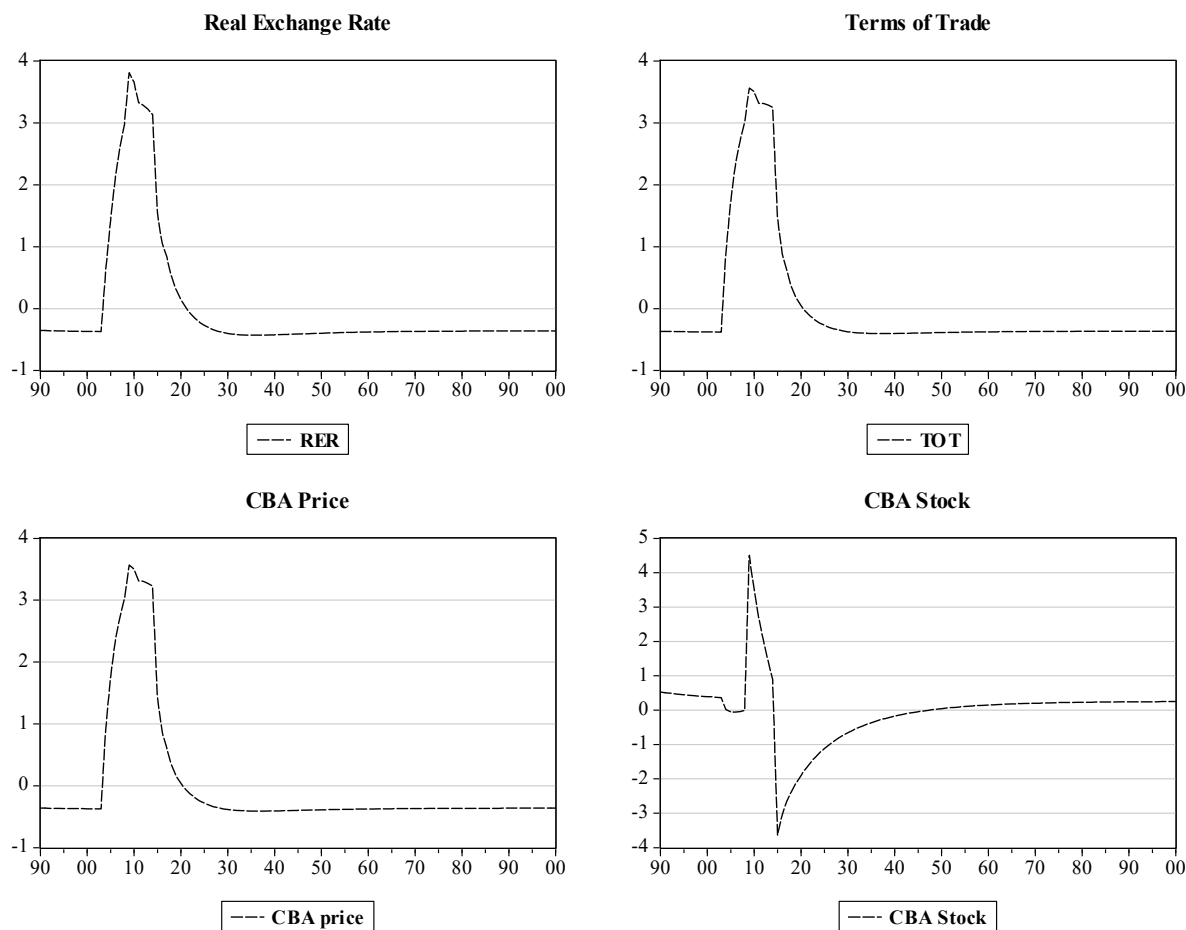

Simulations show that the behavior of the RER follows two elements, namely, CBAs’ price and TOT.

After the initial increase in 2004 in the exogenous demand component for MX exports, TOT improved in MX and deteriorated in the US. In figure 1, from 2004 to 2014, TOT improved by 3.5 SD.

We report the price for CBAs on the right and the RER on the left. Structured notes register an increase in price of almost 4 SDs from 2004 to 2009, confirming the high sensitivity of this specific type of asset to commodity prices. The RER responds by appreciating by a similar magnitude during the same period. Both variables fall after 2009.

Growing prices in CBAs attract foreign investors, who shift their preferences toward CBAs and adjust their portfolios to a new set of asset prices. US households want to hold more CBAs as they expect to increase returns in their portfolio. After the fall in 2008 crisis—modeled by a reduction in the interest rate benchmark from the US by 1 percentage point—interest rates paid on US domestic bills and US deposit decrease, making US investors unhappy about their domestic yield. Thus, they keep a certain proportion of their portfolios allocated toward CBAs. As a result, the price of CBAs only falls slightly in the aftermath of the 2009 crisis, preventing a deep fall in the RER.

To supply a greater number of CBAs and meet the growing demand from domestic households, US financial intermediaries increase the demand for foreign bills—reducing their demand for domestic bills and deposits. A proportion of the new MX bills bought by households is securitized and offered to the US households. This generates higher demand for MX currency. As a result of the improvement in the TOT, the RER registers an upward movement (appreciation).

The four variables reported in figure 1 fall almost back to the original steady state after the double shock in 2014. After 2014, the TOT drops almost 4 SDs because of the reduction in demand for MX exports. The fall in demand for MX exports leads to a negative shock in CBA prices as the US financial sector adjusts its portfolio toward safer securities, such as US domestic bills and US deposits. That is, investors shift their preferences, generating a selloff in MX financial assets—what Dornbusch (1976) and Cavallo et al. (2005) define as *overshooting* of the currency. International investors' portfolios adjust toward a conservative strategy, which financial practitioners commonly define as “flight to quality.” As a result, the price of CBAs falls by 3.5 SDs. Similarly, the stock of CBAs outstanding in the system drops from 0.9 SDs in 2014 to -3.8 SDs in 2016. We observe that the RER depreciates by almost 3 SDs over the next five fictional years.

The negative adjustment in the RER consequent to the selloff in domestic assets highlights the RER's sensitivity to portfolio flows (Dornbusch 1976; Minsky 1996; Harvey 2009). Harvey (2001, 2009) argues that financial elements can affect the currency's trajectory, underlying the fact the RER's long-run path is simply the result of short-run elements. The more shocks the system experiences in the short run, the less likely they are to readjust to the initial value. Look, for example, at the time the RER needs to recover to its initial values. After the initial shock in 2004, the misalignment from the baseline scenario is recovered over a period of 25 fictional years, until

2030. This is in line with the purchasing power parity puzzle put forward by Rogoff (1996) that does not support the idea of the fulfillment of the law of one price for the RER.<sup>4</sup> The RER's nonstationarity implies that when a shock occurs, this price could float away from the original baseline for an extended period of time. In other words, the RER may be subject to hysteresis—that is, a process according to which shocks to economic variables are not completely absorbed over a long-time horizon.

## 5.2 Effect on Trade

The trade channel is the effect that a change in the relative price has on the trade volume, that is the demand for exports and imports. To explore how it functions, in figure 2 we report on the simulation for export and import ratios to GDP, as well as the current and trade accounts. All variables are scaled by GDP.

**Figure 2. Exports, Imports, Trade Balance, and Current Account**

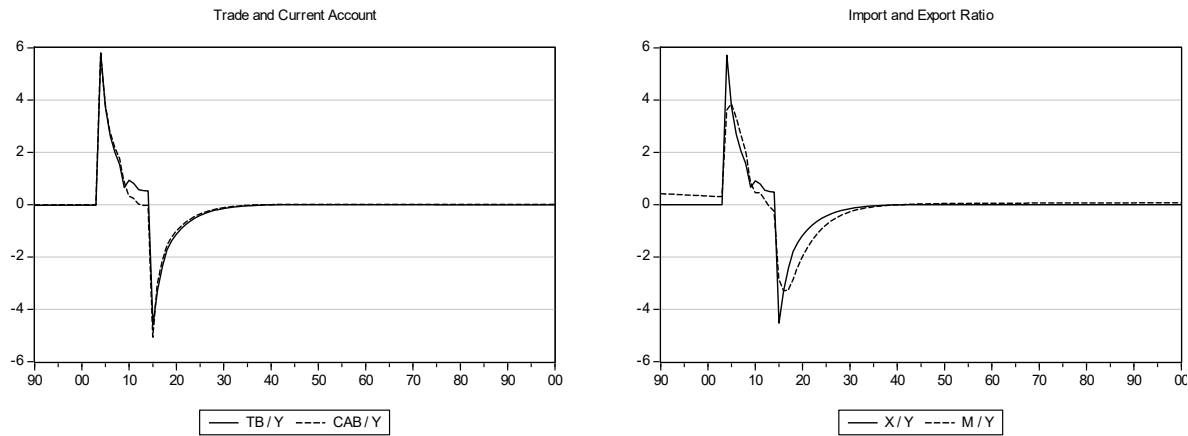

Having imposed an increase in the exogenous parameter for the demand for exports, the volume of exports from MX to US immediately increases. In turn, the current account benefits. Both variables increase by almost 6 SDs immediately after the positive shock in 2004.

<sup>4</sup> The purchasing power parity (PPP) hypothesis holds that national price levels should be equal once converted to a common currency (Rogoff 1996). According to this theory, the difference between domestic and foreign price inflation should equal changes in the spot exchange rate over time, expressed in logarithmic values.

We saw in figure 1 that the improvement in the TOT generates inflows from international investors and currency appreciation in real terms. Eventually, foreign demand for MX exports adjusts to the new, higher RER in the following periods and, consequently, the volume adjusts. This is shown with the downward slope after the initial positive shock. Exports decrease from 6 SDs to 1 SD.

Imports increase as well over the period 2004–8 as the RER appreciates. As explained by the literature, during an expansionary phase in super commodities cycles (Bresser-Pereira 2008; Rodrik 2013), the increase in raw material prices generates more consumption in commodity-exporting countries; higher income generates diversification in consumption, which cannot be completely met by domestic production. Thus, consumers (households), empowered by the real revaluation of their wealth, will start acquiring more products, including foreign ones. In figure 1, imports reach their peak in 2008, right before the financial crisis. Eventually, after a small recovery from 2010 to 2014, imports fall again after the second shock is imposed in 2014. As consumption is a function of income, levels of imports fall with the latter after the end of the commodity boom.

After the currency depreciation in 2014, we also observe corrections in the trade balance, as it falls by 4.5 SDs from 2015 until 2020. After that, it starts a long recovery; it will reach the initial value of zero around the year 2030. The initial fall and the long-run recovery resemble the J-shape behavior predicted by the M-L condition. We explain this behavior by elasticity parameters adopted following Carnevali et al. (2019, 2020), the sum of which is close to unity (0.98). The system uses the competitiveness of the currency as a buffer to slumps in exports and, eventually, output. Both grow steadily eventually.

The current account, after the initial positive spike, starts decreasing as the currency is appreciated and exports become less competitive. The inverse process is observed after the crises of 2008 and 2014, where initially it deteriorates due to lower demand for exports imposed by our experiments, but eventually recovers over a longer period of time, showing J-curve behavior (Magee 1973; Bahmani-Oskooee and Ratha 2004). In the final steady-state equilibrium, the current account and trade balances return to the initial levels in accordance with the balance of payments identities reported in section 3.2.

### 5.3 Effect on Government Finances

RER fluctuations also have an impact on government finances. By changing the level of the RER, the government balance sheet suffers from the revaluation/devaluation of the stock of debt issued in foreign currency and the interests paid on it. Additionally, improvements in the TOT directly affect aggregate demand through changes in consumption and investment. Ultimately, tax revenues, government spending, and debt issuance adjust accordingly. To study how public finances react to the RER, we report the following indicators in figure 3: the government budget, the debt-to-GDP ratio, Kalecki's balance equations, and the foreign-to-domestic-debt ratio.

**Figure 3. Exports, Imports, Trade Balance, and Current Account**

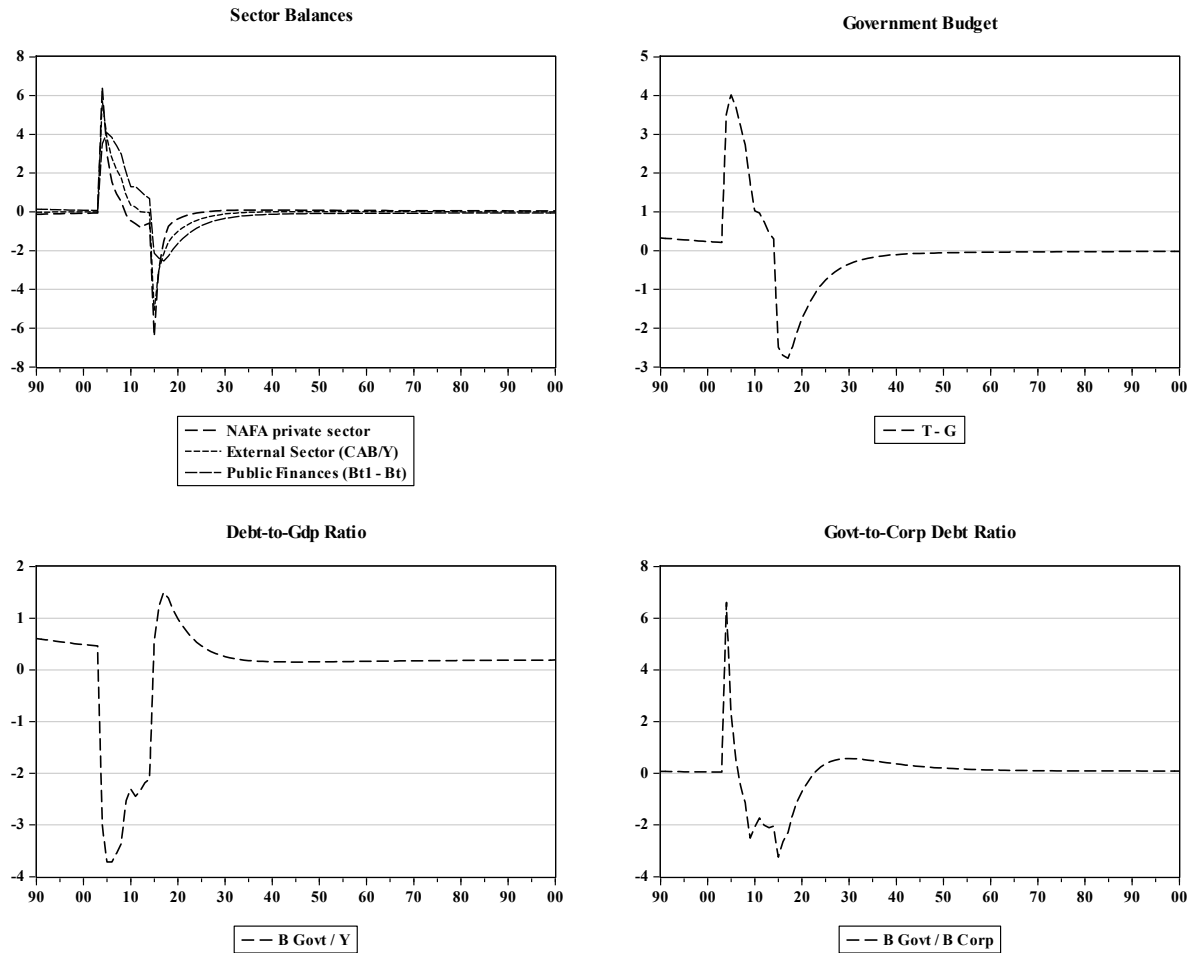

From 2004 to 2014 the constraint relaxes as the economy experiences growth, boosted by higher demand for MX exports and TOT improvement. During this initial phase, household spending is increasing, also boosted by improvement in households' expectations—recall that these are

calculated as the average of the income received in the last two periods. Higher income and expectations further boost consumption. From the government perspective this process is summarized in one thing: higher tax revenues.

In figure 3 we report government revenues calculated as taxes ( $T$ ) minus spending ( $G$ ). After the initial positive shock, the indicator grows by 4 SDs. In 2009, after reaching its peak, it starts falling; however, it is only after the 2014 oil crisis that the system records a government deficit.

The improvement in the budget constraint diminishes the need to issue debt, as reflected in the initial reduction in the stock of MX government debt in figure 3. After the initial positive shock in government revenues by 4 SDs, debt-to-GDP ratio decreases by an almost equivalent value. The indicator then stabilizes around the range of -2.1 SDs to -2.4 SDs from 2010 to 2014.

To put in context how government debt performs relative to the private sector, figure 4 reports the corporate-debt-to-government-debt ratio. An increase (decrease) in the index indicates that the government sector issued a greater (lower) stock of debt than corporate firms. We observe an initial spike after the 2004 exchange rate appreciation. The interpretation of this is that the government sector experiences higher devaluation of its debt after a depreciation compared to the private sector. As a matter of fact, in our set of initial values, the stock of government debt is higher than that of the private sector. Thus, the effect of a debt deflation is higher for the government, as it owns the higher stock of debt.

However, the trajectory of this indicator reverts almost immediately, showing a decreasing marginal accumulation of debt in the government sector compared to private corporations. Eventually, the series turns negative from 2012 to 2015, showing that at that point in the simulation, the corporate outstanding debt outweighs government debt. The minimum is reached in 2015, as the ratio achieved -3.2 SDs. Starting from 2015, the balance sheet effect hurts both sectors, forcing them to clean their balance sheet of foreign debt until they again achieved their initial equilibrium values.

Government performance could be also observed looking at the three Kaleckian equations reported in figure 3. According to Kalecki (1971), the flows generated by fundamental equations in an economy could be seen through the balances of three sectors, i.e., external, government, and private. Flows in the external and government sectors are given by the current account and government



balances, respectively. Concerning the private sector, Kalecki considers the difference between savings and investments as private financial asset acquisition—the part of saving not allocated to physical capital that will be spent on the acquisition of new financial assets.

#### **5.4 Redistribution, Consumption, and Disposable Income**

The redistribution channel implies that when the currency changes its value, the economic system adjusts prices and wages accordingly. Facing a depreciation, domestic prices might increase, and real wages decrease, and vice versa. In line with it, in our system, when the TOT improve and the RER appreciates, real wages also increase. In figure 4, we add a positive spike of 4 SDs to the wage bill, that is, the total amount of salaries multiplied by the total amount of workers. In turn, disposable income will also be higher, allowing households to enjoy a higher level of consumption. In a demand-side model, such as the one presented here, higher consumption is accompanied by higher demand for investments in order to meet the expansion in consumption. In turn, the demand for production factors (labor and capital) increases. With respect to labor, figure 4 reports a 4 SD spike in the employment level.

The wage share, after an initial negative adjustment due to changes in inflation differentials, reaches its peak in 2014, at 4 SDs. It drops with the collapse in asset prices in 2015, however. Two effects work contemporaneously here. From one side, the rise in interest rates in the United States attracts portfolio flows back to the US, depreciating the MX currency, putting pressure on MX domestic prices (through exports), and reducing MX real wages. On the other hand, after the worsening of the terms of trade, the external sector contracts and aggregate demand contracts, too. The level of employment adjusts to the new, lower equilibrium. The combined effect of lower real wages and lower employment levels has a negative impact on disposable income.

As income starts decreasing, future income expectations fall, too, further contracting consumption and aggregate demand. Ultimately, households' wealth falls. Recall from the equations in section 3.1 that households have a target level of wealth they want to maintain (Brainard and Tobin 1968; Tobin 1969, 1981). In order to fill the gap in wealth generated by asset depreciation, households reduce their consumption and increase their saving.

**Figure 4. Real Wages, Employment, Disposable Income, Consumption, and Wage Share**

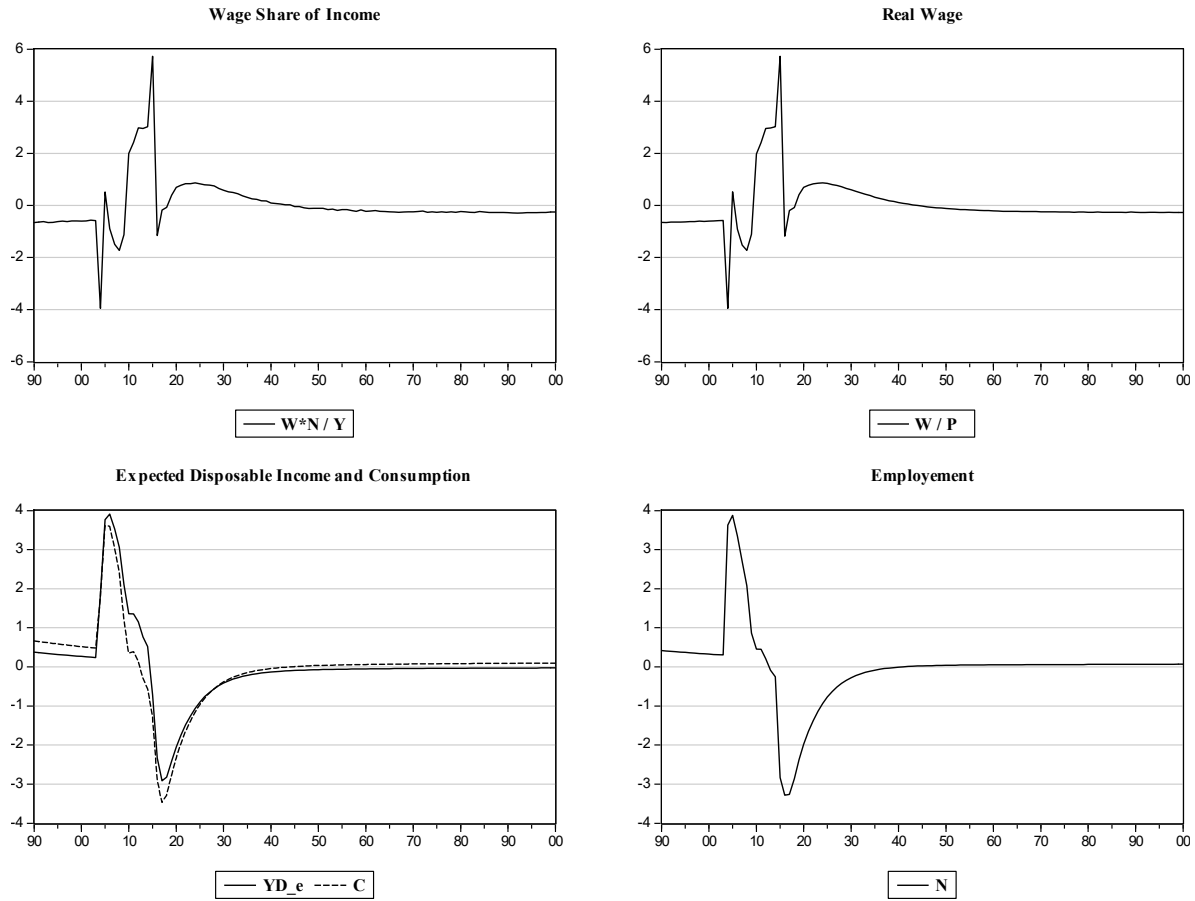

### 5.5 Investment, Corporate Debt, and Balance Sheet Effects

We report in figure 5 several indicators to evaluate the balance sheet effect and its impact on the investment channel, namely, investment flows ( $I$ ), physical capital ( $k$ ), and their respective ratios with GDP ( $I/Y$ ;  $K/Y$ ). In figure 6 we report additional indicators to evaluate the performance of investment and its link with the balance sheet effect. Indicators measure firm's net worth, capacity utilization, internal versus external finance, the debt-to-capital ratio, unitary costs per sales, and the profit-to-capital ratio.

**Figure 5. Investment Flows, Capital Accumulation, and Capital Stock**

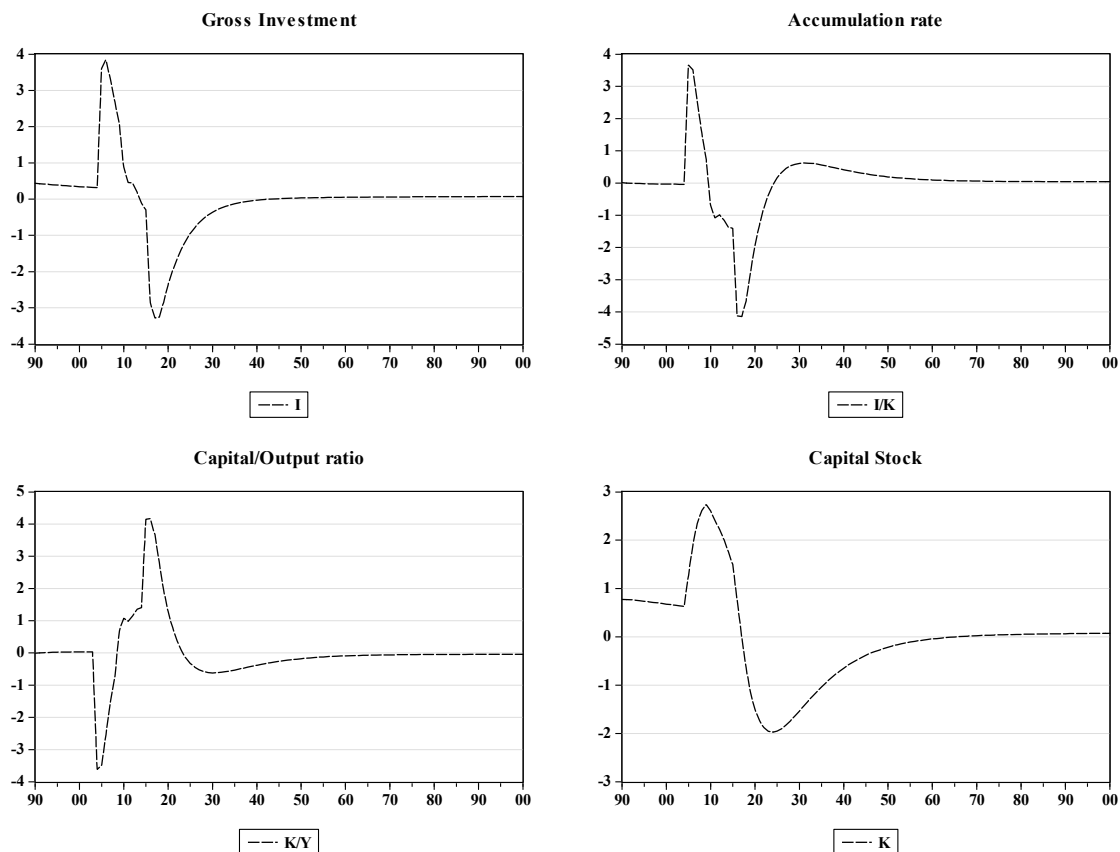

**Source:** Own elaboration.

**Notes:** I= investment flows; K= stock of capital; Y=total output; I/K= rate of capital accumulation.

The initial shock in the demand for exports increases the volume of sales, which ultimately requires a greater level of investment flows from MX firms to catch up with the expanding demand; immediately after the shock in 2004, the index reports a 4 SD spike. Sales are not pressured only by the growing external sector, but also from greater consumption from domestic households, who feel empowered by the real revaluation of their salaries.

Recall from equations (104) through (112) that firms decide to invest according to the target level of capital they establish at the beginning of each period. Target capital, according to equations (103) through (111), is an increasing function of lagged output—the higher the output, the higher the capital target level firms need to achieve to meet demand. The increasing demand is also reflected in the initial higher level of capacity utilization, defined as the ratio of output over capital ( $Y/K$ ).

We observe a spike in the target capital (figure 5) in coincidence with the beginning of the expansionary phase in 2004. Firms initially do not have the physical capital required to respond to higher demand; to do so, they accumulate capital ( $I/K$ ). The ratio  $I/K$  increases by 3.6 SDs, reaching its maximum in 2005 and 2006 (figure 5). As a result, the stock of physical capital in the corporate sector achieved its maximum of 2.8 SDs in 2009, just before the financial crisis occurs.

Figure 5 shows, however, that even if investment, capital accumulation, and stock of capital increased, the penetration of capital in GDP ( $K/Y$ ) initially decreased; we explain this through the relative performance compared with other components of GDP. The increase in capital stock is lower compared to imports, consumption, and exports. Indeed, while capital stock increased only by 2.8 SDs, the other variables increased by 4 SDs, on average. However, the capital stock ratio recovers quickly, reaching positive territory after two years, and arriving at its maximum in 2015, at 4.2 SDs higher.

**Figure 6. Additional Investment Indicators**

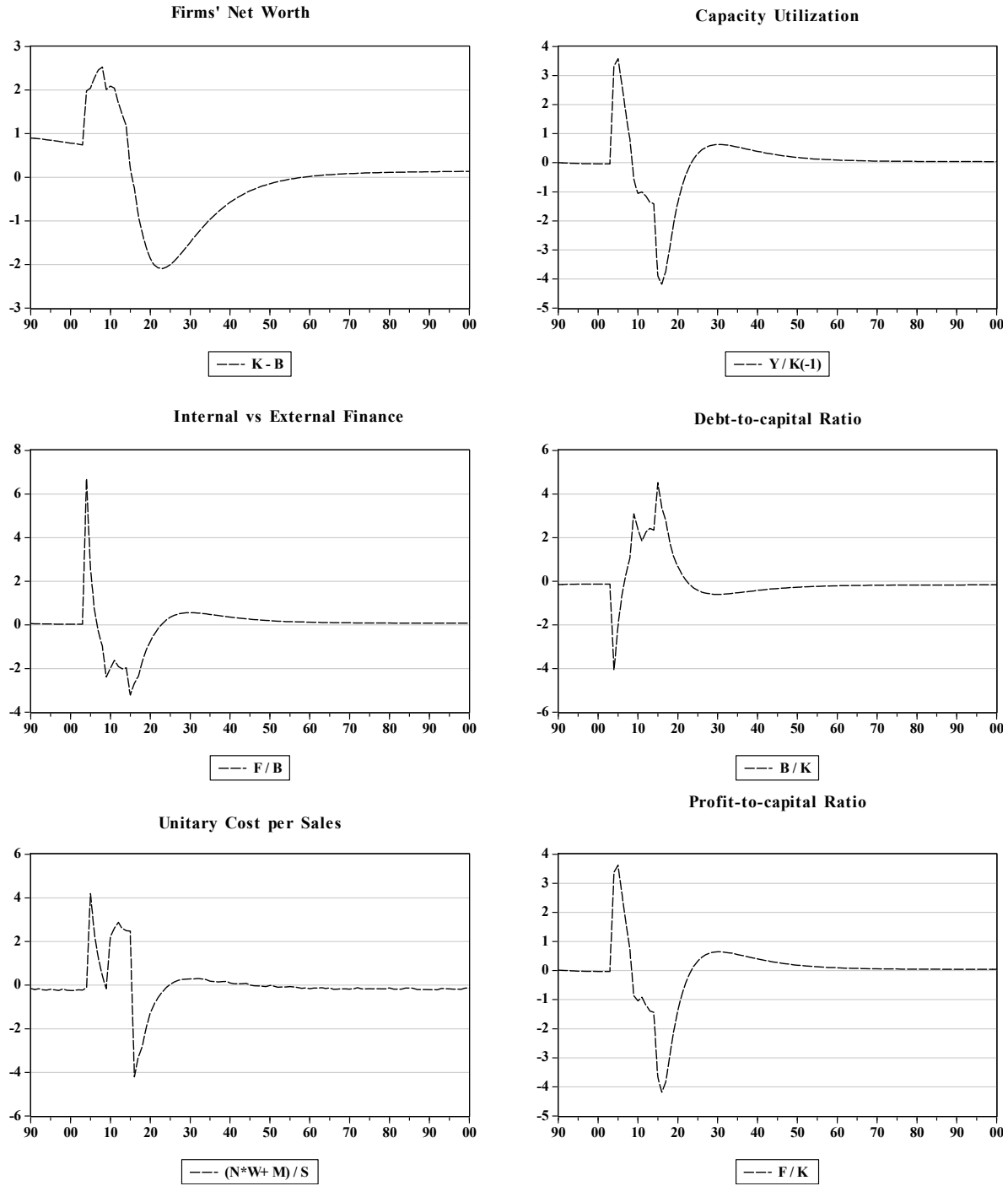

**Source:** Own elaboration.

**Notes:** B=stock of corporate bonds; F=profits; K=capital; M=imports; N=employment; S=sales; and W=wages.

As exports expand and the RER appreciates, aggregate demand slows. Consequently, firms adjust the target of capital they want to acquire.

Starting from 2006, investment flows and capital accumulation slowly decrease. Both series remain well above the initial steady-state levels, though they start following a downward path. We explain this behavior through the Dutch disease effect<sup>5</sup> (Bresser-Pereira 2008; Rodrik 2013).

An important element to consider when looking at capital accumulation is financing. Equations (100) through (108) in the previous section affirm that firms have two ways to finance investment: internal (profits) and external (foreign bonds) financing. Normally, firms use profits to finance investment. However, it could be the case that, even reinvesting profits, firms are still in need of credit to finance the increase in aggregate demand. In this case, external investors provide resources and firms can meet extra demand.

By financing new investment with foreign debt, firms increase foreign liabilities on their balance sheet during expansionary phases. Notice that the trajectory of debt accumulation changes slope in 2009, as soon as interest rates are cut in the United States. Recall that the interest paid on corporate bills is a linear function of the US interest rate. When the US central bank cuts rates by 1 percentage point, the service paid on corporate bills also falls, relaxing the balance constraint for firms by reducing service on foreign debt. During this phase, firms have an incentive to expand their foreign liabilities. The risk with this way of financing investment is that firms accumulate debt through the expansionary phases, but as soon as the currency depreciates, local firms are left with a higher stock of external debt and a lower value in domestic currency. We see this process in the behavior of the debt-to-capital ratio ( $B/K$ ); initially, physical capital stock is higher than debt and therefore the ratio falls by almost 4 SDs after an increase in exports in 2004. After that, the index increases and, eventually, reaches the maximum in 2015, showing a sustained period of indebtedness.

---

<sup>5</sup> This concept was put forward by Corden and Neary (1983) and was named after the economic events experienced by the Dutch economy in the seventies. They noticed that a boom in the resource sector has two basic effects: a spending effect and a resource movement effect. The former leads to an appreciation of the RER, while the latter causes manufacturing to shrink. However, here we tend to adopt the interpretation suggested by Botta (2017). That is, capital inflows lead first to a nominal (and subsequently real) appreciation of the exchange rate, and trigger medium-run financial cycles. Hence, we believe that this should be seen as a financial-driven phenomenon.

**Figure 7. Corporate Sector's Stock of Debt**

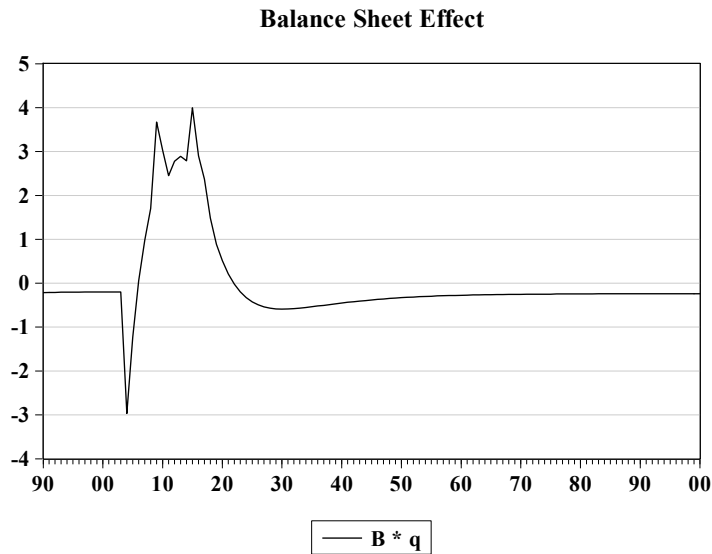

Figure 7 reports the interaction between the exchange rate ( $q$ ) and the corporate sector's stock of debt ( $B$ ) as a proxy for the balance sheet effect. The latter decreases by 3 SDs after the initial appreciation of the RER. The series shows two peaks: in 2009, when the index reached 3.7 SDs, and in 2015, when it reached 4 SDs. Focusing on the latter effect, we observe that in 2014, when the devaluation takes place, the balance sheet effect was stable at 2.8 SDs; after the collapse in the peso, in only one year  $B * q$  increases by 1.2 SDs. The balance sheet effect could be also observed in the decrease in wealth after 2014 episode. In our system, corporate firms have one physical asset (capital) and one financial liability (corporate bonds); the difference between the two is the net wealth of corporate firms.

Additionally, the profit-to-capital ratio's ( $F/K$ ) response also shows a similar trend to capital accumulation and  $B * q$ , as it starts falling after the initial positive spike of 4 SDs. Recall from equations (37) and (38) that the unitary costs include imports as a proxy for intermediary inputs. As a result, in the medium run, we notice a decrease in the profitability of capital since there are higher input costs. In figure 6 we report the unit cost for sales and profit over capital. After 2004, the system experiences an increase in the unitary cost of sales—that is, how much one sale costs after accounting for labor and imports. Focusing on the aftermath of the shock in 2014, we see that even if the unit cost of sales net of debt service falls, investment does not rise.

Capital stock, investment flows, and stock of wealth do not fully recover to the initial steady-state level, showing signs of hysteresis. In other words, the model proves that the negative effect on the balance sheet after a currency depreciation may last over sustained periods of time, limiting the possibility of accumulating capital rather than supporting it.

## 6 CONCLUSION

In the present paper we conducted a scenario analysis to evaluate the theoretical functioning of the RER transmission channels. We selected the episode at the end of the commodity boom and real currency depreciation experimented with in 2014. On that occasion, the currency depreciated as soon as financial investors reversed investment flows; the currency remained depreciated over the next five years but benefits for investment and growth did not materialize. We explain this by stressing the coexistence of multiple transmission channels for the RER that prevent us from establishing *ex ante* a specific outcome for RER undervaluation. The final effect could be ambiguous, benefitting some channels, while hurting others. To explain the multidimensional effect of the RER, we perform a scenario analysis by developing and calibrating an SFC model. We use it to evaluate the response from different channels.

We observed that after a negative shock in the currency, a prolonged period of undervaluation could have long-lasting adverse effects on several variables in the system.

In our simulation we do see a positive effect on trade after depreciation; exports and the trade balance exhibit J-curve behavior and the benefits obtained in the long run only compensate for the initial loss. We attribute this behavior to our elasticity parameters for exports and imports that are close to unity (i.e., close the M-L condition).

An important element for the business cycle is financing (Bernanke and Gertler 1989; Minsky 1996). When corporate firms finance their activity through foreign liabilities, in the long run financial imbalances could emerge and currency undervaluation might have an adverse effect on firms' net worth. During expansionary phases in output, aggregate demand from abroad and domestically could put pressure on firms' capacity utilization, requiring them to increase their



physical capital investment. When internal financing (profits) is not enough, they sell bonds to international investors to obtain credit from the public. This process, if sustained over time, could lead to dangerous imbalances in the private sector as soon as the currency loses its value vis-à-vis the creditor's currency. Investment initially increases from higher demand for exports and improvement in the TOT. However, as imports become cheaper, the MX economy starts to include more foreign goods in their consumption basket, including corporate firms that use imports as inputs in their productive systems. When depreciation materializes, thus, they suffer a reduction in profitability, as unit cost per sales decrease. Additionally, in line with the hypothesis of the current work, corporate firms suffer from the balance sheet effect, i.e., the revaluation in foreign debt and the loss of firms' net worth. As soon as depreciation materializes and the RER remains undervalued (relative to the baseline scenario), net wealth is lower, as well as capital accumulation and capacity utilization. Some variables do not return to their initial equilibrium. Investment flows, consumption flows, and output do not benefit from currency undervaluation. In other words, these three variables reported episodes of hysteresis, that is, they do not fully recover to their preshock equilibrium level.

## REFERENCES

- Acemoglu, D., and M. Dell. 2010. "Productivity differences between and within countries." *American Economic Journal: Macroeconomics* 2(1): 169–88.
- Agénor, P., and P. Montiel. 1999. *Development Macroeconomics*. Princeton, NJ: Princeton University Press.
- Aghion, P., P. Bacchetta, and A. Banerjee. 2001. "Currency crises and monetary policy in an economy with credit constraints." *European economic review* 45(7): 1121–50.
- Alexander, S. S. 1952. "Effects of a Devaluation on a Trade Balance." *Staff Papers-International Monetary Fund* 2(2): 263–78.
- Backus, D., W. C. Brainard, G. Smith, and J. Tobin. 1980. "A model of US financial and nonfinancial economic behavior." *Journal of Money, Credit and Banking* 12(2): 259–93.
- Bahmani-Oskooee, M., and A. Ratha. 2004. "The J-curve: a literature review." *Applied Economics* 36(13): 1377–98.
- Bastourre, D., and N. Zeolla. 2017. "Regulación de la cuenta capital en un mundo financieramente complejo: evolución reciente y perspectivas en América Latina." Comisión Económica para América Latina y el Caribe—Oficina de Buenos Aires. Serie Estudios y Perspectivas No. 52. Buenos Aires: United Nations.
- Benavente, J. M., C. A. Johnson, and F. G. Morande. 2003. "Debt composition and balance sheet effects of exchange rate depreciations: a firm-level analysis for Chile." *Emerging Markets Review* 4(4): 397–416.
- Beranke, B., and M. Gertler 1989. "Agency costs, net worth, and business fluctuations." *American Economic Review* 79(1): 14–31.
- . 1995. "Inside the black box: the credit channel of monetary policy transmission." *Journal of Economic Perspectives* 9(4): 27–48.
- . 2000. "Monetary policy and asset price volatility." NBER Working Paper No. 7559. Cambridge, MA: National Bureau of Economic Research.
- Bernanke, B., M. Gertler, and S. Gilchrist. 1994. "The financial accelerator and the flight to quality." NBER Working Paper No. 4789. Cambridge, MA: National Bureau of Economic Research.
- Bleakley, H., and K. Cowan. 2010. "Maturity mismatch and financial crises: Evidence from emerging market corporations." *Journal of Development Economics* 93(2): 189–205.
- Blecker, R. A., and A. Razmi. 2008. "The fallacy of composition and contractionary devaluations: output effects of real exchange rate shocks in semi-industrialised countries." *Cambridge Journal of Economics* 32(1): 83–109.

- Bonizzi, B. 2015. "Institutional investors and emerging markets with intermediate exchange rate regimes: A stock-flow consistent model." MPRA Paper No. 68103. Munich Personal Archive (RePEc).
- Bonomo, M., B. Martins, and R. Pinto. 2003. "Debt composition and exchange rate balance sheet effect in Brazil: a firm level analysis." *Emerging Markets Review* 4(4): 368–96.
- Bortz, P. G. 2014. "Foreign debt, distribution, inflation, and growth in an SFC model." *European Journal of Economics and Economic Policies: Intervention* 11(3): 269–99.
- Botta, A. 2017. "Dutch Disease-cum-financialization booms and external balance cycles in developing countries." *Brazilian Journal of Political Economy* 37(3): 459–77.
- Brainard, W. C., and J. Tobin. 1968. "Pitfalls in financial model building." *The American Economic Review* 58(2): 99–122.
- Bresser-Pereira, L. C. 2008. "The Dutch disease and its neutralization: a Ricardian approach." *Brazilian Journal of Political Economy* 28(1): 47–71.
- Carnevali, E., M. Deleidi, R. Pariboni, and M. V. Passarella. 2020. "Cross-border financial flows and global warming in a two-area ecological SFC model." Online first, *Socio-Economic Planning Sciences* (2020): 100819.
- Carnevali, E., M. Deleidi, R. Pariboni, and M. V. Passarella. 2019. "Stock-Flow Consistent Dynamic Models: Features, Limitations and Developments." In P. Arestis and M. Sawyer (eds.), *Frontiers of Heterodox Macroeconomics*. London: Palgrave Macmillan.
- Case, K. E., J. M. Quigley, and R. J. Shiller. 2011. "Wealth effects revisited 1978–2009". NBER Working Paper No. 16848. Cambridge, MA: National Bureau of Economic Research.
- Cavallo, M., K. Kisselev, F. Perri, and N. Roubini. 2005. "Exchange rate overshooting and the costs of floating." FRB of San Francisco Working Paper 2005-07. San Francisco: Federal Reserve Board.
- Caverzasi, E., and A. Godin. 2013. "Stock-flow consistent modeling through the ages." Levy Institute Working Paper No. 745. Annandale-on-Hudson, NY: Levy Economics Institute of Bard College.
- Cermeño, R., and H. Rivera. 2015. "Mexico's Trade Flows in the NAFTA era: Evidence on the Marshall-Lerner condition from a VEC-GARCH approach." Available at: <https://www.unige.ch/degit/files/4414/3992/7376/Cermeno.pdf>
- Céspedes, L. F., R., Chang, and A., Velasco. 2004. "Balance sheets and exchange rate policy." *American Economic Review* 94(4) 1183–93.
- Chang, R., and A. Velasco. 1999. "Liquidity crises in emerging markets: theory and policy." *NBER Macroeconomics Annual* 1(14): 11–58.

- Chui, M., E., Kuruc, and P. Turner. 2016. "A new dimension to currency mismatches in the emerging markets-non-financial companies" BIS Working Paper No. 550. Basel: Bank for International Settlements.
- Corden, W. M., and J. P. Neary. 1982. "Booming sector and de-industrialisation in a small open economy." *The Economic Journal* 92(368): 825–48.
- Cripps, F., and W. Godley. 1976. "A formal analysis of the Cambridge Economic Policy Group model." *Economica* 43(172): 335–48.
- Delli Gatti, D., M. Gallegati, B. C. Greenwald, and J. E. Stiglitz. 2007. "Net worth, exchange rates, and monetary policy: the effects of a devaluation in a financially fragile environment." NBER Working Paper No. 13244. Cambridge, MA: National Bureau of Economic Research.
- Deshpande, A. 1997. "The debt overhang and the disincentive to invest." *Journal of Development Economics* 52(1): 169–87.
- Diamond, P. A. 1965. "National debt in a neoclassical growth model." *The American Economic Review* 55(5): 1126–50.
- Díaz-Alejandro, C. F. 1963. "A Note on the Impact of Devaluation and the Redistributive Effect." *Journal of Political Economy* 71(6): 577–80.
- Domar, E. D. 1946. "Capital expansion, rate of growth, and employment." *Econometrica, Journal of the Econometric Society* 14(2): 137–47.
- Dornbusch, R. 1976. "Expectations and exchange rate dynamics." *Journal of Political Economy* 84(6): 1161–76.
- Echeverry, J. C., L. Fergusson, R. Steiner, and C. Aguilar. 2003. "'Dollar' debt in Colombian firms: are sinners punished during devaluations?" *Emerging Markets Review* 4(4): 417–49.
- Forbes, K. J. 2002. "How do large depreciations affect firm performance?" *IMF Staff Papers* 49(1): 214–38.
- Frenkel, R., and J. Ros. 2006. "Unemployment and the real exchange rate in Latin America." *World Development* 34(4): 631–46.
- Funke, N. 2004. "Is there a stock market wealth effect in emerging markets?" *Economics Letters* 83(3): 417–21.
- Furman, J., J. E. Stiglitz, B. P. Bosworth, and S. Radelet. 1998. "Economic crises: evidence and insights from East Asia." *Brookings Papers on Economic Activity* 1998(2): 1–135.
- Galindo, A., U. Panizza, and F. Schiantarelli. 2003. "Debt composition and balance sheet effects of currency depreciation: a summary of the micro evidence." *Emerging Markets Review* 4(4): 330–39.

- Gertler, M., S. Gilchrist, and F. M. Natalucci. 2007. "External constraints on monetary policy and the financial accelerator." *Journal of Money, Credit and Banking* 39(2-3): 295–330.
- Godley, W., and M. Lavoie. 2006. *Monetary economics: an integrated approach to credit, money, income, production and wealth*. New York: Springer.
- Godley, W. 1996. "A simple model of the whole world with free trade, free capital movements, and floating exchange rates." Unpublished Manuscript, Annandale-on-Hudson, NY: Levy Economics Institute of Bard College.
- . 1999. "Open Economy Macroeconomics Using Models of Closed Systems." Levy Institute Working Paper No. 745. Annandale-on-Hudson, NY: Levy Economics Institute of Bard College.
- Goicoechea, J. 2001. "Tipo de cambio Real y comercio exterior en México." In A. Guillén and G. Vidal (eds.), *La Economía Mexicana bajo la Crisis de Estados Unidos*, México: Universidad Autónoma Metropolitana, Unidad Iztapalapa.
- Greenwald, B. C. 1998. "International adjustments in the face of imperfect financial markets." In B. Pleskovic and J. E. Stiglitz (eds.), *Annual World Bank Conference on Development Economics*. Washington, DC: The World Bank.
- Greenwald, B. C., and J. E. Stiglitz. 1993. "Financial market imperfections and business cycles." *The Quarterly Journal of Economics* 108(1): 77–114.
- Gross, T., M. J. Notowidigdo, and J. Wang. 2020. "The marginal propensity to consume over the business cycle." *American Economic Journal: Macroeconomics* 12(2): 351–84.
- Gruss, B. 2014. "After the boom—commodity prices and economic growth in Latin America and the Caribbean." IMF Working Paper No. 154. Washington, DC: International Monetary Fund.
- Harrod, R. F. 1939. "An essay in dynamic theory." *The Economic Journal* 49(193): 14–33.
- Harvey, J. T. 2001. "Exchange rate theory and 'the fundamentals.'" *Journal of Post Keynesian Economics* 24(1): 3–15.
- . 2009. *Currencies, capital flows and crises: A post Keynesian analysis of exchange rate determination*. Abingdon-on-Thames, UK: Routledge.
- Henderson, B. J., N. D. Pearson, and L. Wang. 2015. "New evidence on the financialization of commodity markets." *The Review of Financial Studies* 28(5): 1285–311.
- Hofmann, B., I. Shim, and H. S. Shin. 2016. "Sovereign yields and the risk-taking channel of currency appreciation." BIS Working Paper No. 538. Basel: Bank for International Settlements.

- Izurieta, A. 2003. "Dollarization as a tight rein on the fiscal stance." In L. P. Rochon and M. Seccareccia (eds.), *Dollarization: Lessons from Europe for the Americas*, vol. 22. Abingdon-on-Thames, UK: Routledge.
- Janot, M. M., M. G. P. Garcia, and W. Novaes. 2008. "Balance sheet effects in currency crises: evidence from Brazil." Texto para discussão No. 556. Rio de Janeiro: Departamento de Economia, Pontifícia Universidade Católica do Rio de Janeiro.
- Kalecki, M. 1971. *Selected essays on the dynamics of the capitalist economy 1933–1970*. Cambridge, UK: Cambridge University Press.
- Kaltenbrunner, A. 2015. "A post Keynesian framework of exchange rate determination: a Minskyan approach." *Journal of Post Keynesian Economics* 38(3): 426–48.
- Kearns, J., and N. Patel. 2016. "Does the financial channel of exchange rates offset the trade channel?" BIS Quarterly Review December. Basel: Bank for International Settlements.
- Kiyotaki, N., and J. Moore. 1997. "Credit cycles." *Journal of Political Economy* 105(2): 211–48.
- Krugman, P., and L. Taylor. 1978. "Contractionary effects of devaluation." *Journal of International Economics* 8(3): 445–56.
- Krugman, P. 1999. "Balance sheets, the transfer problem, and financial crises." In P. Isard, A. Razin, and A. K. Rose (eds.), *International finance and financial crises*. Dordrecht: Springer.
- Lavoie, M., and G. Daigle. 2011. "A behavioural finance model of exchange rate expectations within a stock-flow consistent framework." *Metroeconomica* 62(3): 434–58.
- López, G. J., and A. Cruz B. 2000. "'Thirlwall's law' and beyond: the Latin American experience." *Journal of Post Keynesian Economics* 22(3): 477–95.
- Magee, S. P. 1973. "Currency contracts, pass-through, and devaluation." *Brookings Papers on Economic Activity* 1973(1): 303–25.
- Menkhoff, L., and M. P. Taylor 2007. "The obstinate passion of foreign exchange professionals: technical analysis." *Journal of Economic Literature* 45(4): 936–72.
- Minsky, H. P. 1996. "The essential characteristics of Post Keynesian economics." In G. Deleplace and E. J. Nell (eds.), *Money in Motion* London: Palgrave Macmillan.
- Moreno-Brid, J. C. 1999. "Mexico's economic growth and the balance of payments constraint: a cointegration analysis." *International Review of Applied Economics* 13(2): 149–59.
- Nalin, L., and G. T. Yajima. 2019. "Commodity Speculation and Exchange Rate Swings in Latin America: a Stock Flow Consistent (SFC) Analysis." Department of Social Science (DISS) Working Paper Series No. 13. Rome: Sapienza University of Rome.

- Nikiforos, M., and G. Zezza, 2017. “Stock-flow consistent macroeconomic models: a survey.” *Journal of Economic Surveys* 31(5): 1204–39.
- Pacheco-López, P., and A. P. Thirlwall. 2004. “Trade liberalisation in Mexico: rhetoric and reality.” Department of Economics Discussion Paper. No. 4. Kent, UK: University of Kent, School of Economics.
- Pacheco-López, P. 2005. “The effect of trade liberalization on exports, imports, the balance of trade, and growth: the case of Mexico.” *Journal of Post Keynesian Economics* 27(4): 595–619.
- Pérez Caldentey, E., and Moreno-Brid, J. C. 2019. “Thirlwall’s law and the terms of trade: a parsimonious extension of the balance-of-payments-constrained growth model.” *Review of Keynesian Economics* 7(4): 463–85.
- Radelet, S., and J. Sachs. 1998. “The onset of the East Asian financial crisis.” NBER Working Paper No. 6680. Cambridge, MA: National Bureau of Economic Research.
- Rapetti, M. 2013. “Macroeconomic policy coordination in a competitive real exchange rate strategy for development.” *Journal of Globalization and Development* 3(2): 1–31.
- Ribeiro, R. S. M., J. S. L. McCombie, and G. T. Lima. 2019. “Does real exchange rate undervaluation really promote economic growth?” *Structural Change and Economic Dynamics* 52(2): 408–17.
- Rodrik, D. 2008. “The real exchange rate and economic growth.” *Brookings Papers on Economic Activity* 2008(2): 365–412.
- . 2013. “Unconditional convergence in manufacturing.” *The Quarterly Journal of Economics* 128(1): 165–204.
- Rogoff, K. 2001. “The failure of empirical exchange rate models: no longer new but still true.” Economic Policy Web Essay 1(1). Available at: [https://scholar.harvard.edu/files/rogoff/files/51\\_web2001.pdf](https://scholar.harvard.edu/files/rogoff/files/51_web2001.pdf)
- . 1996. “The purchasing power parity puzzle.” *Journal of Economic literature* 34(2): 647–68.
- Ros, J. 2015. *Development Macroeconomics in Latin America and Mexico: Essays on Monetary, Exchange Rate, and Fiscal Policies*. New York: Springer.
- Sachs, J. D. 1989. “Developing Country Debt and Economic Performance. The International Financial System.” In J. D. Sachs (ed.), *Developing Country Debt and Economic Performance, Volume 1: The International Financial System*. Chicago: University of Chicago Press.
- Sachs, J., A. Tornell, and A. Velasco. 1996. “Financial crises in emerging markets: the lessons from 1995.” NBER Working Paper No. 5576. Cambridge, MA: National Bureau of Economic Research.

- Serena, J. M., and R. Sousa. 2017. “Does exchange rate depreciation have contractionary effects on firm-level investment?” BIS Working Paper No. 624. Basel: Bank for International Settlements.
- Spinola, D. 2020. “Debating the assumptions of the Thirlwall Model: A VECM analysis of the Balance of Payments for Argentina, Brazil, Colombia, and Mexico.” UNU-MERIT Working Paper No.1. Maastricht: United Nations University-Maastricht Economic and Social Research Institute on Innovation and Technology (MERIT).
- Thirlwall, A. P. 1979. “The balance of payments constraint as an explanation of the international growth rate differences.” *PSL Quarterly Review* 32(128).
- Thirlwall, A. P., and M. N. Hussain. 1982. “The balance of payments constraint, capital flows and growth rate differences between developing countries.” *Oxford Economic Papers* 34(3): 498–510.
- Tobin, J., and J. Braga Macedo. 1980. “The Short Run Macroeconomics of Floating Exchange Rates.” *Economia* 4(1): 1–23.
- Tobin, J. 1969. “A general equilibrium approach to monetary theory.” *Journal of Money, Credit and Banking* 1(1): 15–29.
- . 1982. “Money and finance in the macroeconomic process.” *Journal of Money, Credit and banking* 14(2): 171–204.
- Valdecantos, S., and G. Zezza. 2015. “Reforming the international monetary system: a stock-flow-consistent approach.” *Journal of Post Keynesian Economics* 38(2): 167–91.
- Zeza, G., and C. H. Dos Santos. 2006. “Distribution and growth in a post-Keynesian stock-flow consistent model.” In N. Salvadori (ed.), *Economic growth and distribution: on the nature and causes of the wealth of nations*. Cheltenham: Edward Elgar.



## APPENDIX 1. PARAMETERS AND INITIAL VALUES

<b>Variables and parameters of the two open economies</b>	<b>Symbols</b>	<b>Baseline values</b>	<b>Scenario values</b>
autonomous demand of LA bills of residents LA	$\lambda_{10}^{LA}$	0.4	
Portfolio parameter of demand for LA bills	$\lambda_{11}^{LA}$	0.5	
Portfolio parameter of demand for LA deposits	$\lambda_{12}^{LA}$	0.25	
Portfolio parameter of demand for LA Derivatives	$\lambda_{13}^{LA}$	0.25	
autonomous demand of deposits LA	$\lambda_{20}^{LA}$	0.4	
Portfolio parameter of demand for LA bills	$\lambda_{21}^{LA}$	0.25	
Portfolio parameter of demand for LA deposits	$\lambda_{22}^{LA}$	0.5	
Portfolio parameter of demand for LA Derivatives	$\lambda_{23}^{LA}$	0.25	
autonomous demand of assets of DER	$\lambda_{30}^{LA}$	0.1	
Portfolio parameter of demand for LA bills	$\lambda_{31}^{LA}$	0.25	
Portfolio parameter of demand for LA deposits	$\lambda_{32}^{LA}$	0.25	
Portfolio parameter of demand for LA Derivatives	$\lambda_{33}^{LA}$	0.5	
autonomous demand of assets of US Bills	$\lambda_{10}^{US}$	0.4	
Portfolio parameter of demand for US bills	$\lambda_{11}^{US}$	0.5	
Portfolio parameter of demand for US deposits	$\lambda_{12}^{US}$	0.25	
Portfolio parameter of demand for US CBAs	$\lambda_{13}^{US}$	0.25	
autonomous demand of Deposits LA	$\lambda_{20}^{US}$	0.4	
Portfolio parameter of demand for US bills	$\lambda_{21}^{US}$	0.25	
Portfolio parameter of demand for US deposits	$\lambda_{22}^{US}$	0.5	
Portfolio parameter of demand for US CBAs	$\lambda_{23}^{US}$	0.25	
autonomous demand of CBA	$\lambda_{30}^{US}$	0.1	

Portfolio parameter of demand for US bills	$\lambda_{31}^{US}$	0.25	
Portfolio parameter of demand for US deposits	$\lambda_{32}^{US}$	0.25	
Portfolio parameter of demand for US CBAs	$\lambda_{33}^{US}$	0.5	
marginal propensity to consume out of income LA	$\alpha_1^{LA}$	0.9	
marginal propensity to consume out of income US	$\alpha_1^{US}$	0.6	
marginal propensity to consume out of wealth LA	$\alpha_2^{LA}$	0.0533	
marginal propensity to consume out of wealth US	$\alpha_2^{US}$	0.2133	
autonomous demand of Exports LA	$\epsilon^{LA}$	- 1.18	-1.08; -1.18
price elasticity of Exports LA	$\eta^{LA}$	0.7	
income elasticity of Exports LA	$\varepsilon^{LA}$	0.8	
autonomous demand of Imports LA	$\varrho^{LA}$	- 3.015	
price elasticity of Imports LA	$\psi^{LA}$	0.7	
income elasticity of Imports LA	$\pi^{LA}$	1.2	
shock to Import price LA	$\mu_0^{LA}$	- 0.00001	
shock to Export price LA	$\chi_0^{LA}$	- 0.00001	
price elasticity of import prices LA	$\mu_1^{LA}$	0.6	
price elasticity of export prices LA	$\chi_1^{LA}$	0.55	
Autonomous parameter LA mark up	$\varphi_0^{LA}$	0	
Autonomous parameter US mark up	$\varphi_0^{US}$	0	
LA marginal Tax Rate	$\theta^{LA}$	0.2	
US Marginal Tax Rate	$\theta^{US}$	0.2	
Fractional Reserve of US intermediaries	$\rho_0^{US}$	0.03	
Fraction of Foreign Bills in US Intermediaries' portfolio	$\rho_1^{US}$	2.7	
Spread between US deposit rate and Bills	$\rho_2^{US}$	0.9	
Mark-up on LA bills	$\rho_3^{US}$	0.05	
Fractional Reserve of LA intermediaries	$\rho_0^{LA}$	0.03	
Fraction of Foreign Bills in LA Intermediaries' portfolio	$\rho_1^{LA}$	0.9	
Spread between LA deposit rate and Bills	$\rho_2^{LA}$	2.7	

Mark-up on US bills	$\rho_3^{LA}$	0.05	
Foreign Reserves LA	$B_{cbLA_s}^{US}$	0.02031	
Real Government Expenditure LA	$g^{LA}$	16	
Real Government Expenditure US	$g^{US}$	16	
Labor Productivity LA	$pr^{LA}$	0.8	
Labor Productivity US	$pr^{US}$	1.3333	
Interest Rate on LA Bills	$r^{LA}$	0.03	0; 0.03
Interest Rate on US Bills	$r^{US}$	0.03	
Deposit Rate US	$r_d^{US}$	0.01	
Deposit Rate LA	$r_d^{LA}$	0.01	
Corporate securities Rate US	$r_c^{US}$	0.0315	
Corporate securities Rate LA	$r_c^{LA}$	0.0315	
Interest Rate on CBA	$r_{cba}$	0.16	
Price of CBA	$P_{cba}$	6.25	
Interest Rate on DER	$r_{der}$	0.16	
Price of DER	$P_{der}$	6.25	
Autonomous parameter Wage rate LA	$W_0^{LA}$	0	
Autonomous parameter Wage rate US	$W_0^{US}$	0	
Autonomous parameter Wage rate US	$\Omega^{US}$	0.7	
Autonomous parameter Wage rate LA	$\Omega^{LA}$	0.2	
Autonomous parameter mark-up US	$\Phi^{US}$	1	
Autonomous parameter mark-up LA	$\Phi^{LA}$	1	
Autonomous parameter employment US	$\zeta^{US}$	1	
Autonomous parameter employment LA	$\zeta^{LA}$	0.9	
Real Government Expenditure LA	$g^{LA}$	16	
Real Government Expenditure US	$g^{US}$	16	

# APPENDIX 2. MODEL VALIDATION

A) Output auto-correlation

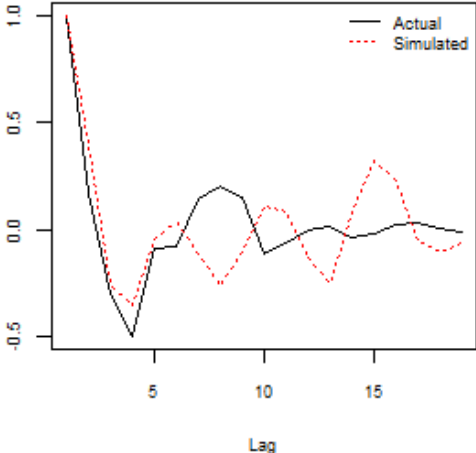

B) Output-consumption cross-correlation

